

TEORIA ELETTROMAGNETICA DELLE GUIDE

Partendo da equazione delle onde

MAXWELL EQUATION
↓
WAVE EQUATION (x, y, z, t)

we simplify by assuming:

- ① HOMOGENEOUS MATERIAL
(only in the core, or in the cover, then match conditions)
- ② ISOTROPIC MATERIAL
(characteristics do not depend on dimension)
- ③ z invariant, $n(x, y)$ doesn't change with z
- ④ $e^{j\omega t}$ sinusoidal (removes dependency on time)
↳ LINEAR MATERIAL
- ⑤ $e^{-j\beta z}$

$$\left(\frac{\partial^2}{\partial x^2} + \frac{\partial^2}{\partial y^2} + \partial_z^2 \right) \vec{E} = 0$$

$$\nabla_t^2 \vec{E} + (\kappa^2 \cdot n(x, y) - \beta^2) \vec{E} = 0$$

write for CORE and COVER, use separation of variable to solve it

we impose field continuity at the interface (CONDIZIONI AL CONFINO DI SOTTO-SEZIONI)

$$\kappa^2 = \kappa_0^2 \cdot n^2, \quad \kappa_0 = \frac{2\pi}{\lambda} \text{ wave number}$$

numero d'onda → n° DI CICLI IN UN INTERVALLO DI SPAZIO

• there are 2 classes of solution:

- DISCRETE SOLUTIONS → GUIDED MODES (Real values of β) $0, 1, \dots, N$
- CONTINUOUS SOLUTIONS → RADIATIVE MODES Plane Waves

- Eigenvectors: MODES, shape of the electric field

- Eigenvalues: PROPAGATION CONSTANT $\beta = \frac{2\pi}{\lambda} \cdot n_{eff}$

• MODE PROPERTIES

- GUIDED MODES: confined to the waveguide

ORTHOGONAL in space, time (do not exchange power)

z independent \rightarrow the component on x, y is purely imaginary

Propagates as $e^{-j\beta z}$

- RADIATIVE MODES: have a transverse component on x, y , removes power

When β is purely imaginary they are evanescent in z

\hookrightarrow free space propagation

- LEAKY MODES: not modes of the structure, they change shape

• ANY PROPAGATING FIELD CAN BE EXPRESSED AS:

$$E(x, y) = \underbrace{\sum_m a_m e_m(x, y)}_{\substack{\text{GUIDED MODES} \\ \text{(DISCRETE)}}} + \underbrace{\int_0^\infty a(\beta) e_R(\beta, x, y) d\beta}_{\text{RADIATIVE MODES}}$$

(+ LEAKY MODES)

RAY OPTICS APPROXIMATION

• SLAB WAVEGUIDE

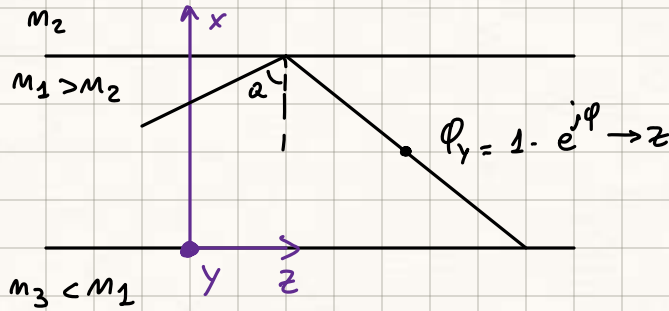

$$E_x, E_y, E_z$$

$$H_x, H_y, H_z$$

$$\frac{\partial}{\partial y} = 0$$

~~$$E_x, E_y, E_z$$~~
~~$$H_x, H_y, H_z$$~~

TE SOLUTION: transverse-electric, no electric field in the direction of propagation

$E_z, E_x, H_y \neq 0$ TM SOLUTION

• GENERAL WAVEGUIDE: we have all 6 components

wave equation:

$$\frac{\partial^2 E_y(x)}{\partial x^2} + [n(x)^2 \cdot k_0^2 - \beta^2] \cdot E_y(x) = 0$$

we can assume one field component and calculate the others

• E_y :

FIELD:

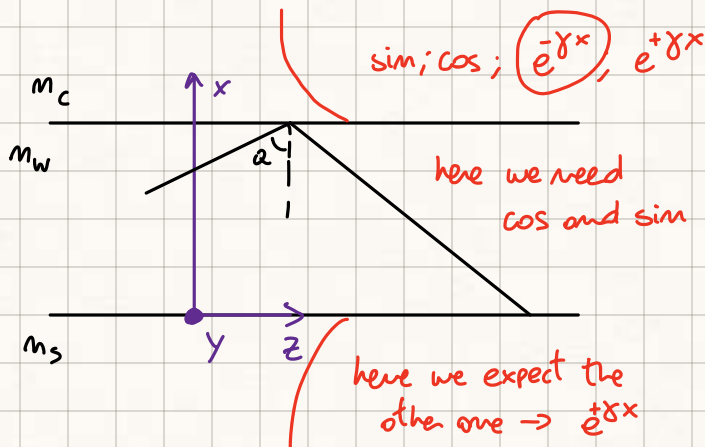

→ we want a field = 0 when going to infinite
↳ $e^{-\delta x}$

field decreases exponentially

Hypothesis:

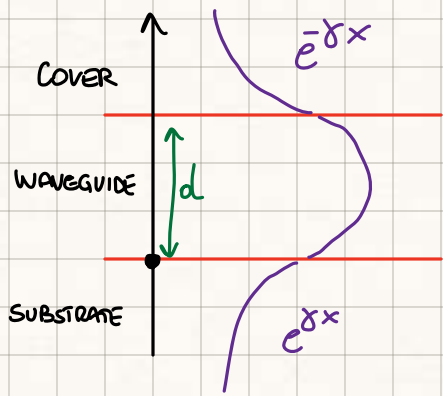

$$\left\{ \begin{array}{l} E_{y \text{ COVER}} = E_c \cdot e^{-\gamma_{\text{COVER}}(x-d)} \\ E_{y \text{ WAVEGUIDE}} = E_w \cdot \cos(k_w x - \phi_s) \\ E_{y \text{ SUBSTRATE}} = E_c \cdot e^{\gamma_{\text{SUBSTRATE}} \cdot x} \end{array} \right.$$

the same, but x is negative

we match the solution at the two interfaces

the three equations have a dependence on z and time

$$e^{-j\beta z} e^{j\omega t} \rightarrow \text{we simplify using the three components}$$

- the physical meaning of γ_c is the decay of the field in the cover
↳ small γ_c makes the field penetrate more into the cover
- k_w is the TRANSVERSE WAVE VECTOR, defines the shape of the field in the waveguide

$$\gamma_c, \gamma_s, k_w, \beta$$

- WE IMPOSE CONTINUITY AT THE INTERFACES: we get 3 relations

$$k_w^2 = k_0^2 M_{\text{eff}}^2 - \beta^2$$

$$-\gamma_s^2 = M_s^2 k_0^2 - \beta^2$$

$$-\gamma_c^2 = M_c^2 k_0^2 - \beta^2$$

- $X=0$ WAVEGUIDE-SUBSTRATE INTERFACE :

$$E_{ys} = E_{yw} \rightarrow \bar{E}_s \cdot \hat{z} = E_w \cdot \cos(-\phi_s)$$

$$H_{zs} = H_{zw} \rightarrow E_s \gamma_s = -E_w k_w \sin(-\phi_s)$$

we find: $\frac{\gamma_s}{k_w} = \tan(\phi_s)$

- $X=d$ WAVEGUIDE-COVER

$$E_{yw} = E_{yc} \rightarrow E_c = E_w \cos(k_w d - \phi_s)$$

$$H_{zw} = H_{zc} \rightarrow E_c \gamma_c = E_w k_w \sin(k_w d - \phi_s)$$

we find: $\frac{\gamma_c}{k_w} = \tan(k_w d - \phi_s)$

we put everything together:

$$t_g(k_w d) = \frac{k_w (\gamma_c + \gamma_s)}{k_w^2 - \gamma_c \gamma_s} \quad \text{EIGENVALUE EQUATION}$$

β is 'hidden' because γ, k_w depend on β

↳ we want to obtain the numerical value of β

from the input: $n_1, n_2, n_3, \lambda, d$

CUTOFF CONDITION: when $\gamma \rightarrow 0$

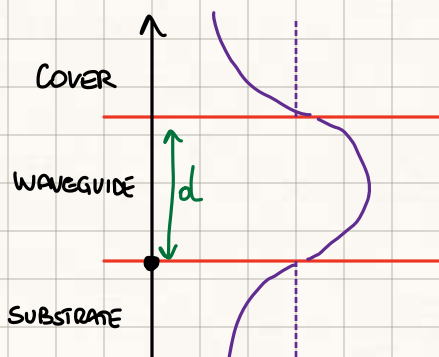

The field becomes constant, infinite energy, no guided propagation

$$\gamma_s = 0 : t_g(k_w d) = \frac{\gamma_c}{k_w}$$

for the ray representation all the points in the same position must arrive with the same phase to another position:

$$k_w = \frac{2\pi \cdot m_w}{\lambda} \rightarrow \frac{2\pi}{\lambda} m_w \cdot d - \phi_s - \phi_c = 2\pi N \quad \text{CUTOFF PHASE CONDITION}$$

choosing a wavelength or dimension d we set the cutoff condition where the mode is no longer guided

$$\frac{d}{\lambda_{\text{cutoff}}} = \frac{N}{2\sqrt{m_w^2 - m_s^2}}$$

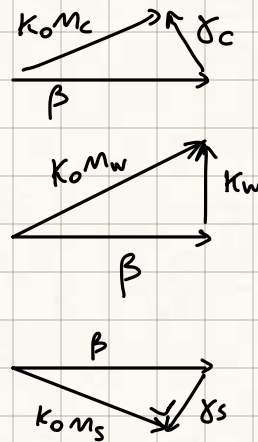
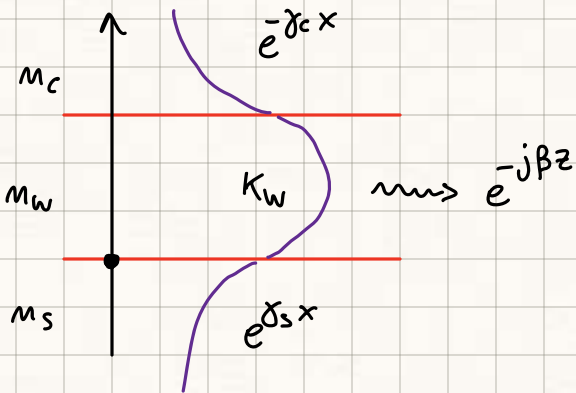

$$k_w^2 = k_0^2 m_w^2 - \beta^2$$

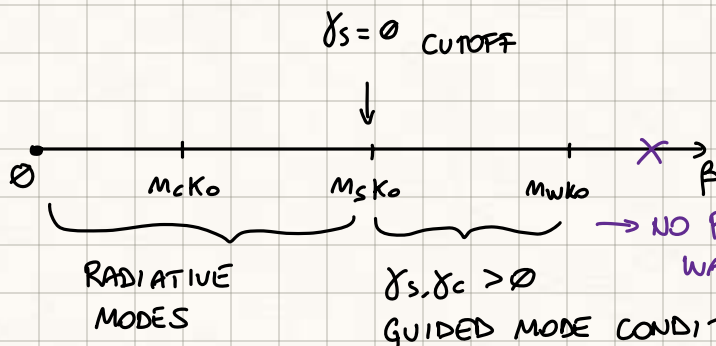

When the waveguide is symmetric $m_c k_0 = m_s k_0$

→ NO PHYSICAL SOLUTION THAT HAVE β LARGER THAN THE WAVE VECTOR OF THE CORE MATERIAL

'RADIATIVE': if $\gamma_s = 0$ then $\beta = k_0 m_s$ then γ_s becomes imaginary going towards 0

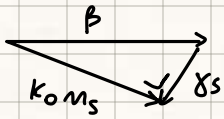

$$\gamma_s = j k_s$$

wave propagates along x direction \rightarrow power exits the waveguide

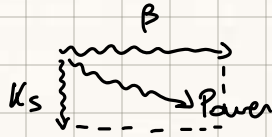

$m_s k_0 \leq \beta \leq m_w k_0$ GUIDED RANGE:

we have a DISCRETE number of β (solutions) \rightarrow 0 if below cutoff
 1 single mode
 N multi-mode

$- m_s k_0 < \beta < m_s k_0$ RADIATIVE:

β is continuous, every value of β can be a solution,
 the shape of the mode is a plane wave, β gives the direction

OMEGA-BETA DIAGRAM: ω - β

solve with fixed m_c, m_w, m_s, d

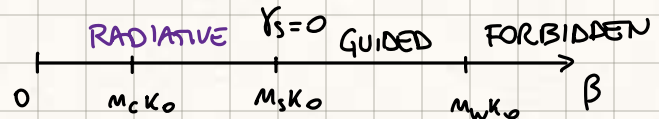
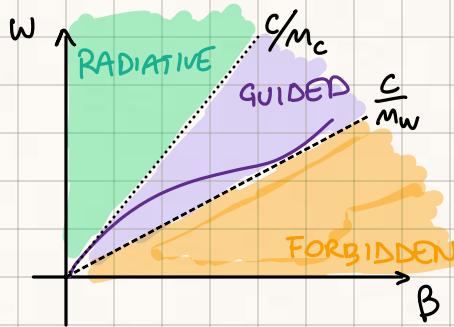

$$\beta = k_0 \cdot m_{eff}$$

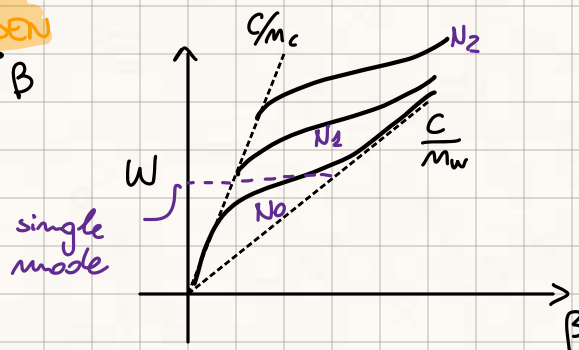

EFFECTIVE INDEX: between m_s and m_w

weighted sum of m_s, m_w depending on mode shape

PHASE VELOCITY:
 of the mode

$$v_p = \frac{\omega}{\beta} = \frac{2\pi f}{k_0 m_{eff}} = \frac{2\pi f}{\frac{2\pi f}{\lambda} m_{eff}} = \frac{c}{m_{eff}}$$

\rightarrow vacuum

it's the rate of variation of the phase along the distance of propagation

GROUP VELOCITY: velocity of information, or of the energy

$$v_g = \left. \frac{\partial \omega}{\partial \beta} \right|_{\omega=\omega_0} = \frac{c}{n_g}$$

n_g is the group index

operating with a single mode is important: in case of multimode the energy is split between different modes which travel at different speed and this creates overlaps at the receiver

$$v_g = \frac{\partial \omega}{\partial \beta} = \frac{1}{\partial \beta / \partial \omega} = \frac{1}{\frac{\partial}{\partial \omega} \left(\frac{\omega}{c} n_{\text{eff}}(\omega) \right)} = \frac{c}{n_{\text{eff}} + \omega \frac{\partial n_{\text{eff}}}{\partial \omega}} = \frac{c}{n_g}$$

$$n_g = n_{\text{eff}} + \omega \frac{\partial n_{\text{eff}}}{\partial \omega}$$

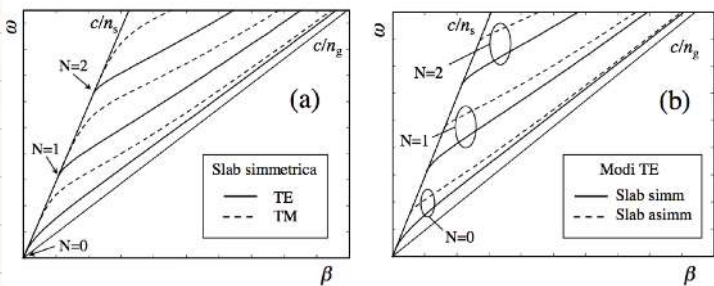

when designing waveguide we should dimension the core to be at the cutoff of the second mode

BIREFRINGENCE: $B = n_{\text{eff TE}} - n_{\text{eff TM}}$

SHAPE OF THE MODES:

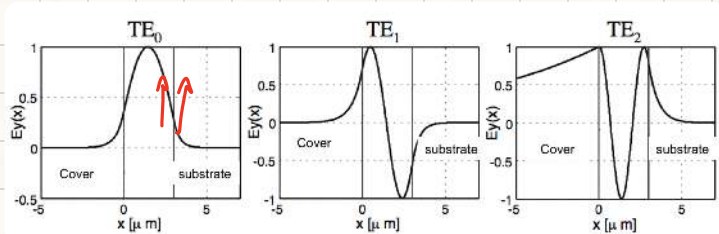

in the second mode $\cos(k_w x + \phi)$
 k_w propagation vector gets bigger, we have faster oscillation

as k_w gets bigger the mode is less confined

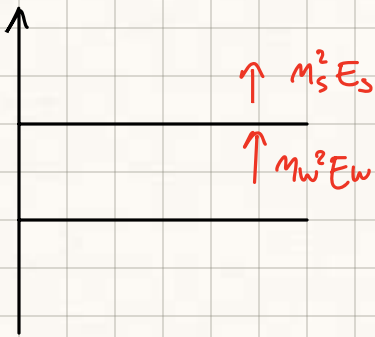

$$\epsilon_s E_s = \epsilon_w E_w$$

$D_s = D_w$ for the TM mode the D is equal

plotting only E_x, E_y sometimes we could have discontinuities of the field

E_x, TM_0

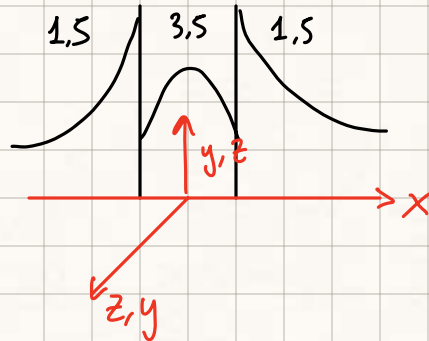

→ discontinuity of E_x but not in D since the index is very different

Magnetic field is related with the derivative of the electric field

↳ we can have discontinuities plotting the magnetic fields

while in the TE the electric field is parallel to the interface, the continuity is in the Electric field → is always continuous



CONTINUITY AT THE INTERFACES:

we conserve the normal field component, in the TE the field is normal then the profile is continuous.

in the TM the field is tangent → D is conserved instead and $D_s = D_w$ then we see the "jump" due to the difference in $m_s \neq m_w$

GROUP INDEX: $m_g = m_{eff} - \lambda \frac{\partial m_{eff}}{\partial \lambda}$

ex: $\lambda = 1,55 \mu m$

$m_{eff} = 2,800249$

↳ at λ :

$$m_g = 2,80 - 1,55 \cdot \frac{-0,004392}{0,01} = 3,57376$$

$m_{eff}' = 2,795257$

$$v_g = \frac{c}{m_g}$$

to excite higher order modes we need misalignment of the waveguide

↳ the efficiency is given by the overlap integral:

$$\int \phi_w \cdot \phi \, dx dy$$

mode of the fiber and considered mode

PROPERTIES OF WAVEGUIDES:

waveguides provide confinement in the x,y directions

modes are never pure TE or TM → quasi-TE, quasi-TM

we design the waveguide depending on the objective

↳ INDEX CONTRAST $\Delta n = \frac{n_w - n_s}{n_w}$

MONOMODALITY, BIREFRINGENCE, COUPLING EFFICIENCY, MAX CURVATURE,
POSSIBILITY TO REALIZE COUPLERS

DIMENSIONING OF THE GUIDES:

d → we consider wavelength and n_s, n_w

$$\frac{d}{\lambda_{\text{cutoff}}} = \frac{N}{2 \sqrt{n_w^2 - n_s^2}} \rightarrow \text{more complicated for TE, TM}$$

this only for the symmetric

conditions to achieve:

• **MONOMODALITY**: fixed n_w, n_c, n_s we modify d

dimension of the plane slab guide with the same indexes

we want to achieve BETTER CONFINEMENT without MULTIMODALITY

• BIREFRINGENCE :

depends on $\begin{cases} \rightarrow \text{Material Birefringence } B_m \\ \rightarrow \text{Dimensional Birefringence } B_f \end{cases}$

one is given by the material and on the interfaces

$\hookrightarrow n_x \neq n_y$

the other on the h/w relation in the dimensioning

\hookrightarrow we could dimension one to compensate the other
(or use complex shapes)

• POLARIZATION DEPENDENT LOSS

Difference in min-max loss of the guide varying polarization

• INSERTION LOSS:

at fiber-waveguide interface, depends on the OVERLAP INTEGRAL OF THE TWO MODES

• BEATING LENGTH:

the fundamental and the first order mode do not exchange power but they generate a periodic field configuration

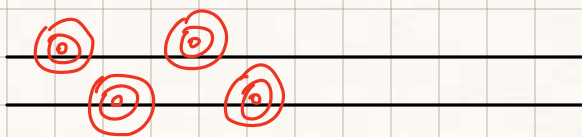

The two modes have DIFFERENT PHASE CONSTANT
they periodically go out of phase

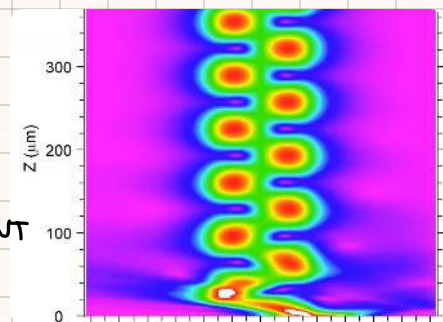

BEATING LENGTH:

$$L_B = \frac{\lambda}{\delta m_{eff}}$$

SOLUTION TO MATHEMATICAL PROBLEM:

$$\frac{\partial^2 \varphi}{\partial x^2} + \frac{\partial^2 \varphi}{\partial y^2} + \frac{\partial^2 \varphi}{\partial z^2} + k_0^2 m^2(x, y, z) \varphi = 0$$

has solution in the form:

$$\varphi(x, y, z) = A(x, y, z) \cdot e^{-j\beta z}$$

↳ A varies slowly in z

GUIDE CURVE:

every point in the transversal plane travels at the same speed

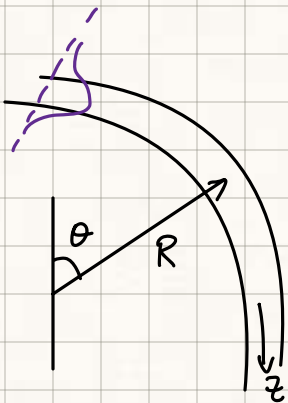

$$r \cdot \frac{d\theta}{dt} = \frac{\omega}{\beta(r)}$$

phase constant β depends on the distance of the radius

$$\beta(r) = \beta_0 \cdot \frac{R}{r} \quad \text{where } \beta_0 \text{ is at the CENTER OF THE GUIDE}$$

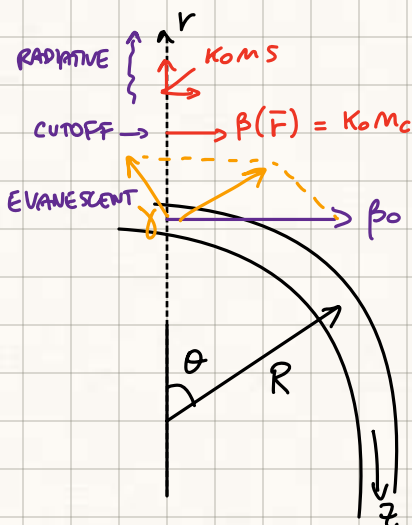

we study the curve as a straight waveguide with change in transversal direction

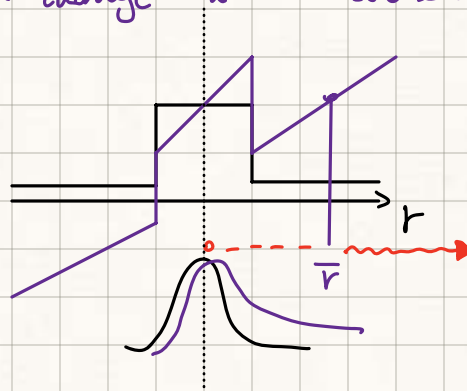

β_r diminishes externally \rightarrow there's a point where $\beta(\bar{r}) = k_0 m_c$

CUTOFF CONDITION

after this point we have transverse radiation

reducing R the cutoff comes closer to the guide \rightarrow losses increase

FUNDAMENTAL MODE OF A CURVED WAVEGUIDE IS A LEAKY ONE

\hookrightarrow we can ignore losses increasing R

index for large radiuses:

$$m(x,y) = m_0(x,y) \cdot \left(1 + \frac{2x}{R}\right), \quad x = r - R$$

EFFECTIVE REFRACTIVE INDEX:

$$\beta_c = \beta_0 + \frac{B}{R^2} \quad \rightarrow \text{parameter}$$

LOSSES:

$$\alpha \propto e^{-C \cdot R}$$

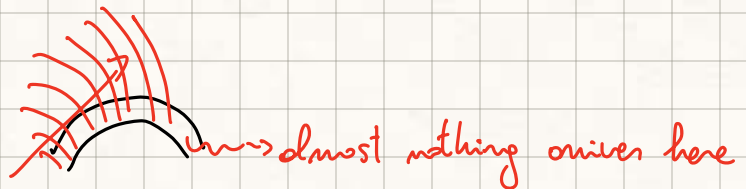

we can filter out higher order modes since they get irradiated quicker than the fundamental one

PROBLEMS EXPERIENCED WHEN BENDING WAVEGUIDE:

- 1) Mode distortion (attenuation is negligible)
- 2) Higher order mode excitation
- 3) Effective index perturbation $\beta_r = \frac{2\pi}{\lambda} m_{\text{eff}} = \beta_0 + \frac{B}{R^2}$
- 4) Radiative losses

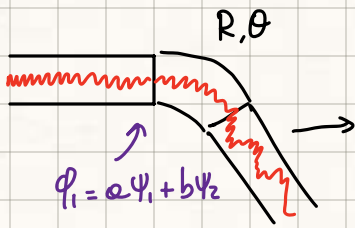

if the phase shift introduced by the bend is not matched then the modes (fundamental and higher order) will resonate and cause beatings \rightarrow we must design carefully the LENGTH OF THE BEND

We can think of the BEND MODE as a linear combination of the first two modes of the straight waveguide (fundamental + higher order)

$$\psi_b = a_1 \phi_1 + a_2 \phi_2$$

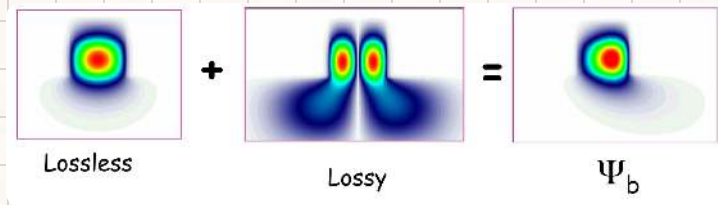

ACCOPIATORI E DIVISORI: COUPLERS / SPLITTERS

Based on COUPLERS MODES THEORY

Uses waveguides close together, less than $1/\gamma$ that influence each other

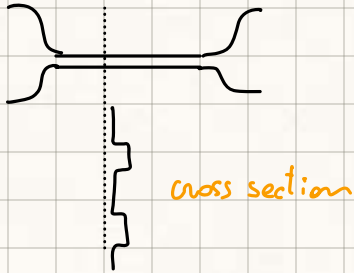

COUPLED MODES THEORY:

Coupled structures are always at least bimodal

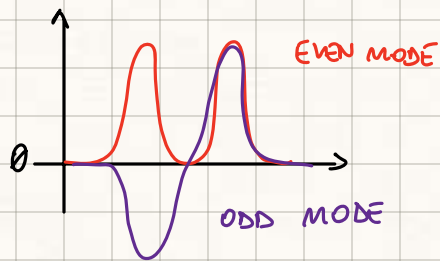

Knowing these modes we can describe the evolution of all fields in the structure

$$\begin{aligned} \text{FIELDS OF THE SINGLE GUIDES} &\rightarrow \varphi_1 = \varphi_s + \varphi_a \\ &\varphi_2 = \varphi_s - \varphi_a \end{aligned}$$

$$\begin{aligned} \varphi_1 &\rightarrow \beta_1 &\Rightarrow & \beta_s \text{ symmetric mode} \\ \varphi_2 &\rightarrow \beta_2 && \beta_a \text{ asymmetric mode} \end{aligned}$$

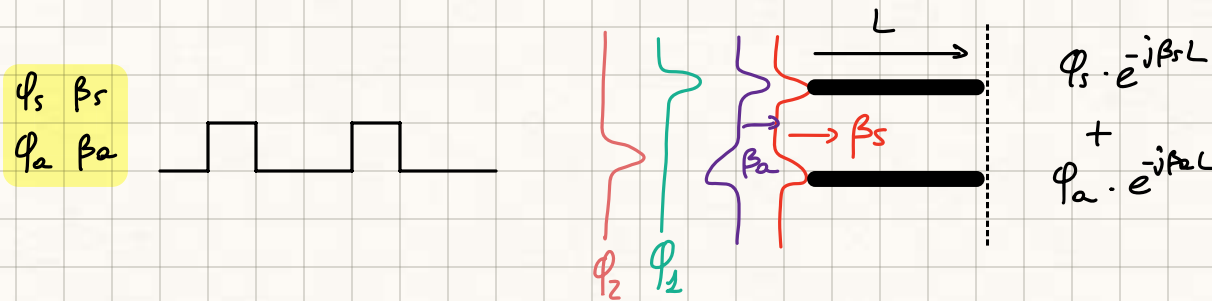

DRAWBACKS OF COUPLED MODES THEORY: we need to calculate φ_a , φ_s and then pass to the single-waveguide representation

φ_s , φ_a are EXACT MODES of the structure, they propagate orthogonally and with different phase velocities $\beta_s \neq \beta_a$

They're amplitude is CONSTANT, does not depend on propagation direction

$$\phi_1 = \frac{\phi_s + \phi_e}{2}, \quad \phi_2 = \frac{\phi_s - \phi_e}{2} \quad \text{are APPROXIMATE MODES:}$$

they're combinations of the exact modes, they change shape while propagating since $\beta_s \neq \beta_a$

They're the modes of the single waveguides, they're not the exact solution for the structure but can be used as a good approximation

• Observation on phase difference along the guide:

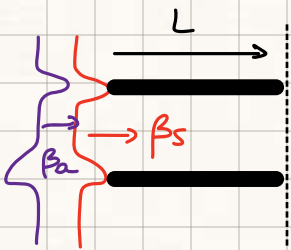

$$\beta_s L - \beta_a L = \pi$$

beating condition for which the two modes exchange sign

↳ power is only in one of the guides:

$$L = \frac{\pi}{\beta_s - \beta_a}$$

→ depending on L the power will be split over the two waveguides in different measure

• FORMAL DERIVATION OF EM MODEL EQUATION:

• we consider the profile index of the whole structure $n(x,y)$ and the one of the single guides $n_1(x,y)$, $n_2(x,y)$

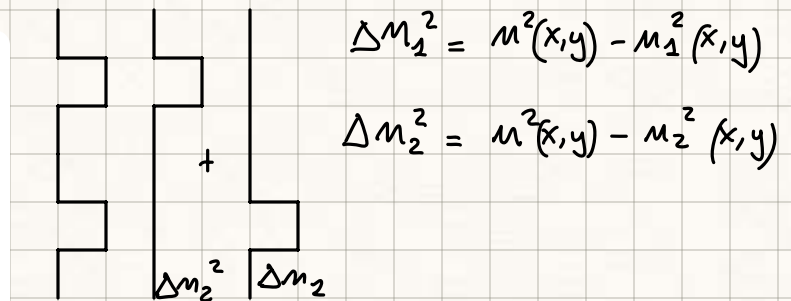
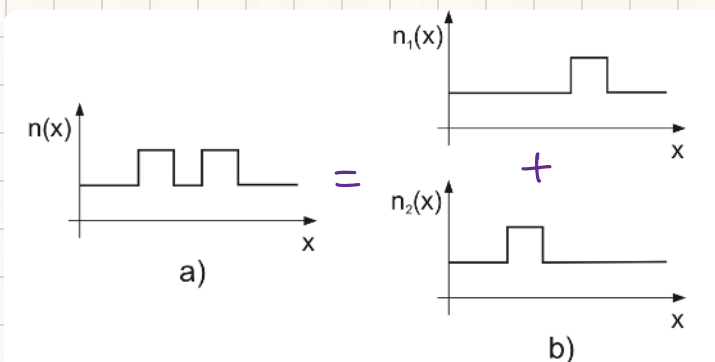

$$\Delta m_1^2 = m^2(x,y) - m_1^2(x,y)$$

$$\Delta m_2^2 = m^2(x,y) - m_2^2(x,y)$$

Δm_2 is 0 everywhere except where the perturbation is

wave equation of the structure is:

$$\nabla_t^2 \Psi + \frac{\partial^2 \Psi}{\partial z^2} + k_0^2 n^2(x, y) \Psi = 0$$

Ψ is the TOTAL FIELD

approximation for weak-coupling condition:

$$\Psi(x, y, z) \approx A(z) \varphi_1(x, y) e^{j\beta_1 z} + B(z) \varphi_2(x, y) e^{-j\beta_2 z}$$

$$= A_0 \varphi_s e^{-j\beta_s z} + B_0 \varphi_a e^{-j\beta_a z}$$

FINAL RESULT

→ RIGOROUS BUT WE DON'T KNOW THE VALUES $\varphi_s, \varphi_a, \beta_s, \beta_a$

φ_s, φ_a modes of the structure, their amplitude is CONSTANT, does not depend on propagation direction

→ A_0, B_0
FOR WEAKLY COUPLED GUIDES

substituting Ψ we obtain:

$$k_0^2 \Delta n_1^2 A \Psi_1 + k_0^2 \Delta n_2^2 B \Psi_2 e^{j\Delta\beta z} - 2j\beta_1 \Psi_1 \frac{dA}{dz} - 2j\beta_2 \Psi_2 \frac{dB}{dz} e^{j\Delta\beta z} = 0$$

$$\Delta\beta = \beta_1 - \beta_2$$

we obtain the COUPLED EQUATIONS by projecting over Ψ_1, Ψ_2 :

$$\int (\varphi_1 \Delta n_1^2 + \varphi_2 \Delta n_2^2 + \varphi_1 + \varphi_2) \cdot \varphi_1^* \approx 0$$

• HOW THE AMPLITUDE OF THE ORIGINAL MODES EVOLVES IN TIME WHEN COUPLED

$$\begin{cases} \frac{dA}{dz} = -j k_{11} A(z) - j k_{12} B(z) e^{j\Delta\beta z} \\ \frac{dB}{dz} = -j k_{22} B(z) - j k_{21} A(z) e^{-j\Delta\beta z} \end{cases}$$

COUPLING COEFFICIENT

$$k_{22}, k_{21}$$

How the complex amplitude of the first mode changes along the structure

↳ it depends on its own amplitude through some coefficients and on the amplitude of the other mode

we get to this result ignoring the projection of Ψ_1 on Ψ_2 and viceversa due to weak coupling

FIELD COUPLING COEFFICIENT:

$$K_{ij} = \frac{k_0^2}{2\beta_i} \frac{\iint \varphi_j \varphi_i^* \Delta n_j^2}{\iint \varphi_j \varphi_i^*}$$



$$K_{ij} \propto \iint \varphi_i \varphi_j \Delta n_j^2$$

perturbation of the structure to the waveguide done

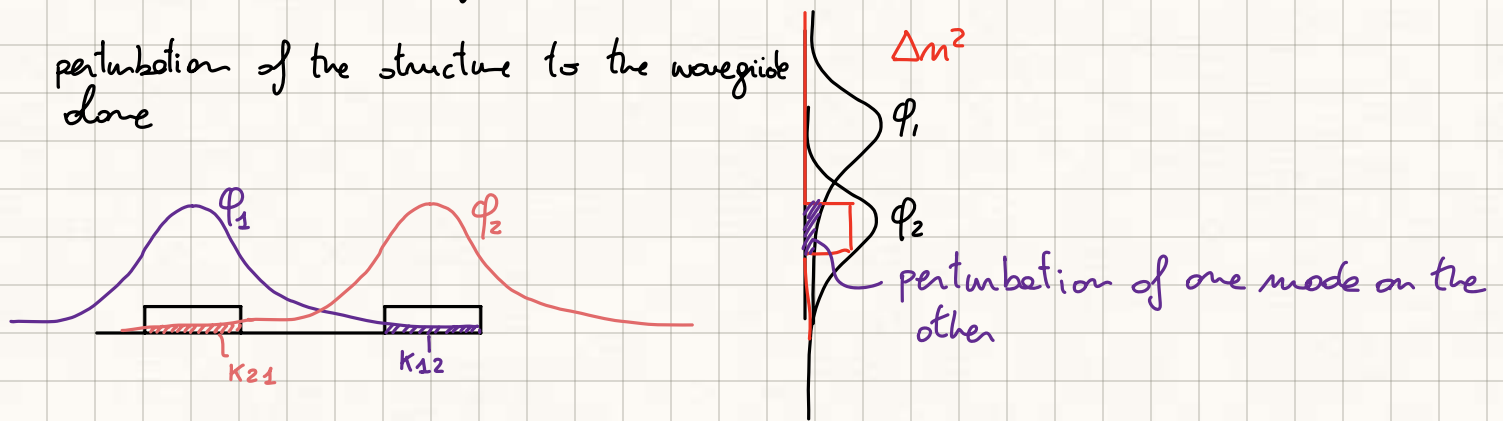

we consider the solution as a wave and rewrite the system of equations as:

1) define: $a(z) = A(z) e^{-j\beta_1 z}$

$$b(z) = B(z) e^{-j\beta_2 z}$$

2) $\frac{da}{dz} = -j(\beta_1 + K_{11})a(z) - jK_{12}b(z)$

$$\frac{db}{dz} = -j(\beta_2 + K_{22})b(z) - jK_{21}a(z)$$

K_{12} and K_{21} represent the coupling between the two waveguides, they're identical for symmetrical structures and tend to 0 increasing the distance between the two

Exact solution of the field equation is:

$$\Psi = A \cdot \Psi_a e^{-j\beta_a z} + B \Psi_s e^{-j\beta_s z}$$

• SOLUTION OF COUPLED EQUATIONS:

we suppose that two modes (waves) exist:

$$a_s e^{-j\beta_s z}, a_a e^{-j\beta_a z}$$

propagating in the structure (without changing shape or amplitude)

we substitute in the system of equations:

$$\begin{aligned} \frac{da}{dz} &= -j(\beta_1 + \cancel{k_{11}}) a(z) - j k_{12} b(z) \\ \frac{db}{dz} &= -j(\beta_2 + \cancel{k_{22}}) b(z) - j k_{21} a(z) \end{aligned} \rightarrow \begin{cases} a_s(\beta - \beta_1) - k_{12} \cdot a_a = 0 \\ -k_{21} a_s + a_a(\beta - \beta_2) = 0 \end{cases}$$

negligible

we get an eigenvalue problem, a solution exists only if $\det \neq 0$

$$\begin{vmatrix} (\beta - \beta_1) & -k_{12} \\ -k_{21} & (\beta - \beta_2) \end{vmatrix} \rightarrow \beta_{s,a} = \frac{\beta_1 + \beta_2}{2} \pm \sqrt{\frac{(\beta_1 - \beta_2)^2}{4} - k_{12} \cdot k_{21}}$$

we obtain the values of β for the two modes starting from the β of the uncoupled modes

↳ EIGENVECTORS are the FIELD CONFIGURATION:

$$a(z) = a_s \cdot e^{-j\beta_s z} + a_a e^{-j\beta_a z}$$

$$b(z) = \frac{\beta_s - \beta_1}{k_{12}} \cdot a_s \cdot e^{-j\beta_s z} + \frac{\beta_a - \beta_2}{k_{21}} \cdot a_a \cdot e^{-j\beta_a z}$$

are the amplitude of the fields in the two waveguides

↳ from this in every section of the structure given the fields in the guides we can obtain the amplitudes of a_s, a_a

we express the input field as the sum of the two modes and use the system to find the amplitude at a given point

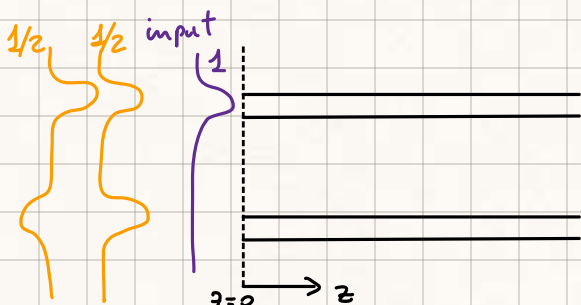

$$a(z) = \frac{1}{2} e^{-j\beta_s z} + \frac{1}{2} e^{-j\beta_a z}$$

$$b(z) = \dots$$

we can find a TRANSFER FUNCTION instead of solving the problem every time

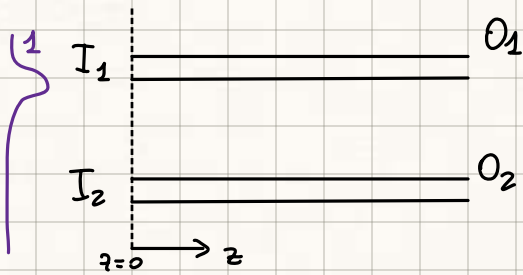

$$\begin{bmatrix} O_1 \\ O_2 \end{bmatrix} = T_c \begin{bmatrix} I_1 \\ I_2 \end{bmatrix}$$

I_1, I_2 complex amplitude at input

O_1, O_2 complex amplitude at output

COUPLING MATRIX:

$$T_c = \begin{bmatrix} \cos \delta z - jR \sin \delta z & -jS \sin \delta z \\ -jS \sin \delta z & \cos \delta z + jR \sin \delta z \end{bmatrix}$$

$$R = \frac{\Delta\beta}{2\delta}$$

$$\Delta\beta = \beta_1 - \beta_2$$

$$S = \frac{K}{\delta}$$

$$K = \sqrt{K_{12} K_{21}}$$

$$\delta = \sqrt{\frac{\Delta\beta^2}{4} + K^2}$$

LOSSLESS CASE: $\det(T_c) = 1$, periodic behavior along z

SYNCHRONOUS COUPLER: equal waveguides

$$\varphi_1 = \varphi_2, \quad \beta_1 = \beta_2 = \beta_0 \rightarrow \text{Meff are equal}$$

$$\Delta\beta = 0$$

$$R = 0, \quad \delta = K, \quad S = 1$$

$$T_{c, \text{synch}} = \begin{bmatrix} \cos Kz & -j \sin Kz \\ -j \sin Kz & \cos Kz \end{bmatrix}$$

Assume input $\begin{bmatrix} 1 \\ 0 \end{bmatrix}$

$$\begin{bmatrix} \cos Kz & -j \sin Kz \\ -j \sin Kz & \cos Kz \end{bmatrix} \begin{bmatrix} 1 \\ 0 \end{bmatrix}$$

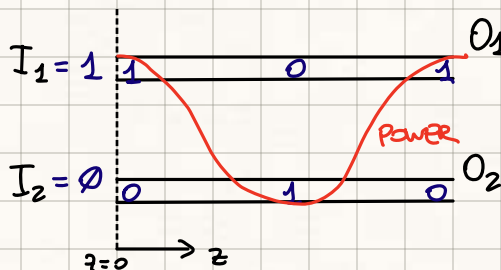

Power is exchanged between the two waveguides, it's the behaviour of the field amplitude

(exchange can be considered for coupled mode theory approximation)

For the synchronous coupler the two modes are in quadrature in the waveguides

INTENSITY IN UPPER AND LOWER WAVEGUIDES:

$$|a(z)|^2 = 1 - \frac{\kappa^2}{\delta^2} \sin^2(\delta z) \quad \text{when } a(0) = 1 \quad b(0) = 0$$

$$|b(z)|^2 = \frac{\kappa^2}{\delta^2} \sin^2(\delta z)$$

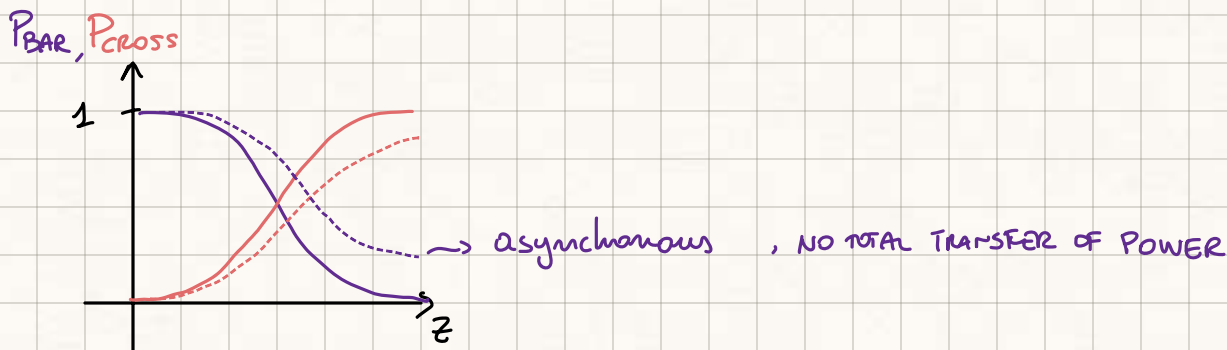
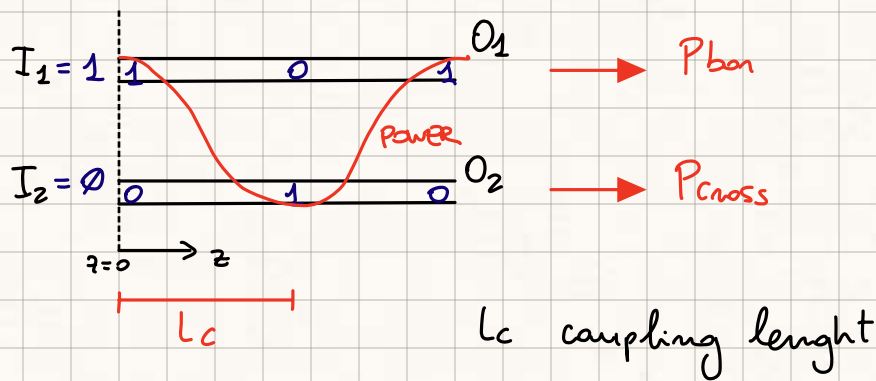

COUPLING LENGTH: length for which we have maximum transfer of power

$$2 L_c \delta = \pi \rightarrow L_c = \frac{\pi}{2\delta} = \frac{\pi}{\beta_s - \beta_a}$$

beating length \rightarrow period of the power exchange

max power exchange : $|b|_{\max}^2 = \frac{\kappa^2}{\delta^2}$

• DIRECTIONAL COUPLER

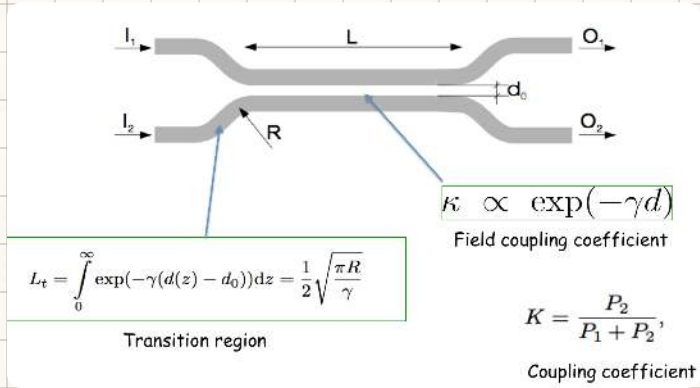

• POWER COUPLING COEFFICIENT :

$K = \frac{P_{\text{cross}}}{P_{\text{bar}} + P_{\text{cross}}}$ splitting ratio of the coupler

$K = \sin^2(\kappa L)$ $\kappa = \sqrt{\kappa_{12} \cdot \kappa_{21}}$

↳ from this we can get $L = \text{minimum coupling length}$

$\kappa L = \sin^{-1}(\pm \sqrt{K})$

Power evolution over the guides

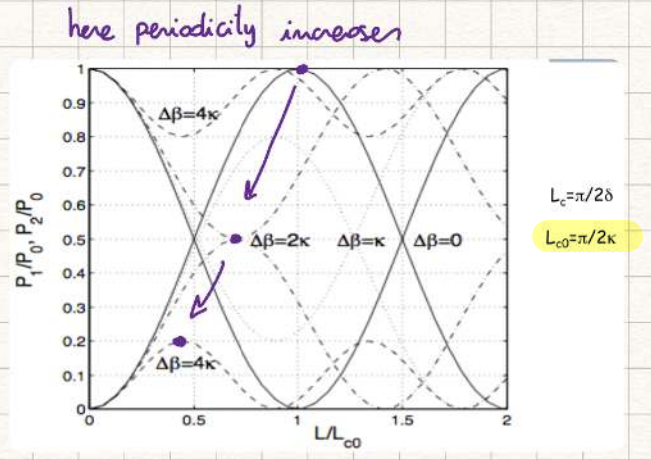
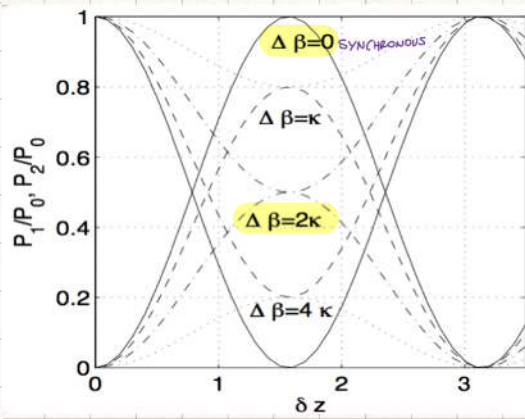

increasing $\Delta\beta$ means FASTER but LESS EFFICIENT coupling

↳ if $\Delta\beta = 0$ we get total transfer of power after length $L_{co} = \frac{\pi}{2\kappa}$

$T_c = \begin{bmatrix} \cos(\kappa L) & -j \sin(\kappa L) \\ -j \sin(\kappa L) & \cos(\kappa L) \end{bmatrix}$

we get periodic power exchange:

$$P_1(z) = P_0 \cos^2(\kappa z)$$

$$P_2(z) = P_0 \sin^2(\kappa z) \quad (\text{Amplitude of the fields})$$

Phases of the field can be obtained:

↳ for synchronous coupler we get a $\Delta\varphi = \pi/2$ independent from frequency (for asynchronous must be recalculated)

↳ when input is $\begin{bmatrix} 1 \\ 0 \end{bmatrix}$

DIMENSIONING: impose K and fix guides (κ and $\Delta\beta$) and obtain L

κ depends on the distance of the guides = $e^{-\gamma d}$

$$|a(z)|^2 = 1 - \frac{\kappa^2}{\delta^2} \sin^2(\delta z)$$

MINIMUM SENSIBILITY CONDITION:

$$\Delta\beta = 2\kappa \sqrt{\frac{1}{K} - 1}, \quad L = \frac{\pi}{2\kappa} \sqrt{K}$$

$$|b(z)|^2 = \frac{\kappa^2}{\delta^2} \sin^2(\delta z)$$

if the guides are close together κ is big \rightarrow small dimension but sensible to errors



Figura 2.6: Accoppiatore direzionale.

↳ transition zones means that coupling happens in a longer zone

$$L_t = \frac{1}{2} \sqrt{\frac{\pi R}{\gamma}}$$

↳ we consider $L + 2L_t$ to compensate for the transitions

- 3dB COUPLER $K = 0,5$

$$\text{if } \Delta\beta = 0 \rightarrow \kappa L = \pi/4 \cdot (2N+1)$$

$$L = \frac{\pi}{4\kappa} \cdot (2N+1)$$

$$T_c = \frac{1}{\sqrt{2}} \begin{bmatrix} 1 & -j \\ -j & 1 \end{bmatrix}$$

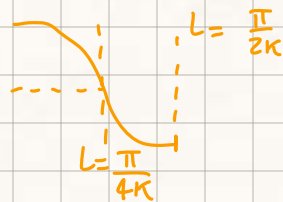

if $\Delta\beta \neq 0$ we can still get -3 dB for $\Delta\beta \leq 2\kappa$

↳ limit case $\Delta\beta = 2\kappa$

$$\kappa L = \frac{\pi}{2\sqrt{2}}$$

$$T_c = \frac{-j}{\sqrt{2}} \begin{bmatrix} 1 & 1 \\ 1 & -1 \end{bmatrix} \rightarrow \text{output fields are in quadrature}$$

we get resistance to sensibility but we need different β on the guides

$$\Delta\beta = 0 \quad T_c = \frac{1}{\sqrt{2}} \begin{bmatrix} 1 & -j \\ -j & 1 \end{bmatrix} \quad \left\{ \begin{array}{l} 1/2j \\ 1/2 \end{array} \right.$$

$$\Delta\beta = 2\kappa \quad T_c = \frac{-j}{\sqrt{2}} \begin{bmatrix} 1 & 1 \\ 1 & -1 \end{bmatrix} \quad \left\{ \begin{array}{l} 1/2 \\ 1/2 \end{array} \right.$$

both behave as a power splitter, the first one keeps a phase term that must be considered when concatenating other elements

the two solutions have differences in sensibility to changes of κ :

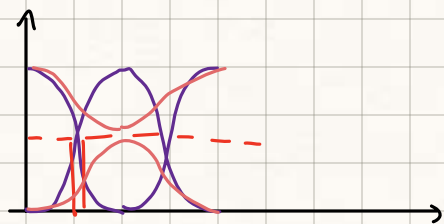

for $\Delta\beta = 2\kappa$ we have a smaller slope, while

$\Delta\beta = 0$ is more sensible to errors

• WDM COUPLER:

κ is proportional to λ : $\kappa = \kappa_0 \cdot \lambda_i$

κ grows with growing λ but $\Delta\beta$ can be chosen to remove this dependence

we have a coupler with length L ,

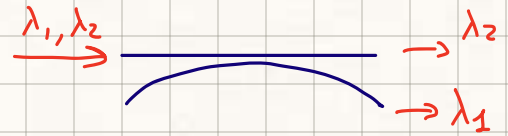

↳ ENTER GUIDE 1 WITH TWO SIGNALS AT λ_1, λ_2

$$P_{\text{bar}}(L, \lambda_2) = \cos^2(\kappa_2 L) = \cos^2(\kappa_0 \lambda_2 \cdot L) = 1$$

$$P_{\text{cross}}(L, \lambda_1) = \sin^2(\kappa_1 L) = \sin^2(\kappa_0 \lambda_1 \cdot L) = 1$$

$$\kappa_0 \lambda_2 L = \pi N_1 \quad (\text{bar})$$

$$\kappa_0 \lambda_1 L = \pi \left(N_2 \pm \frac{1}{2} \right) \quad (\text{cross})$$

it works only for N INTEGER \rightarrow we could raise $N \rightarrow$ long waveguide

we can round N and approximate considering some losses

• COUPLER WITH GRATING:

we can obtain max power coupling in an asynchronous coupler

↳ $\beta_1 \neq \beta_2$

$$|b(z)|^2_{\text{max}} = \frac{\kappa^2}{\delta^2}$$

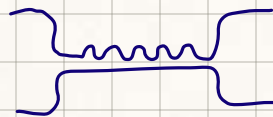

$P_{\text{bar}}, P_{\text{cross}}$

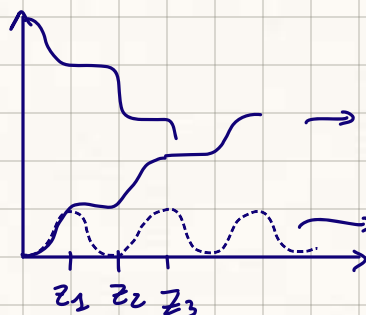

\rightarrow we separate the guides when the power would decrease

\rightarrow no grating

Y-BRANCH

we can use coupled mode theory \rightarrow two modes of the central guide + modes of bifurcations

(when the central guide is monomodal, the second mode is radiative)

\hookrightarrow we use a taper before the bifurcation to make it bi-modal

transition happens at MAX 2° - 3°

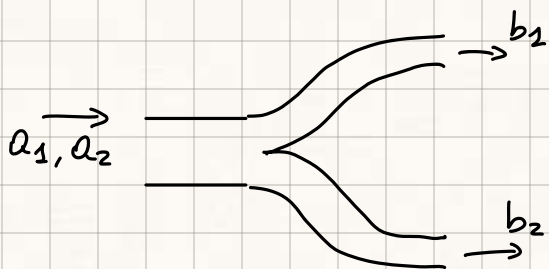

$$\begin{bmatrix} b_1 \\ b_2 \end{bmatrix} = T_Y \begin{bmatrix} a_1 \\ a_2 \end{bmatrix}$$

$$T_Y = \frac{1}{\sqrt{2}} \begin{bmatrix} 1 & 1 \\ 1 & -1 \end{bmatrix}$$

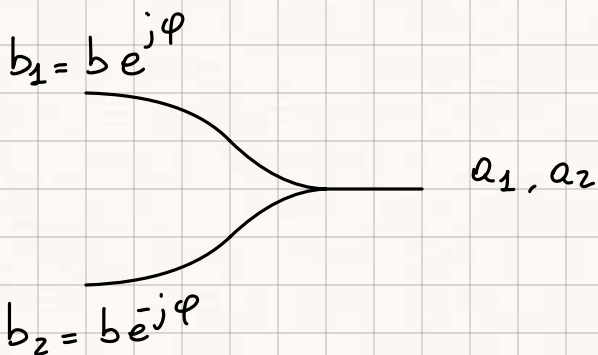

$$\begin{bmatrix} a_1 \\ a_2 \end{bmatrix} = T_Y \begin{bmatrix} b e^{j\varphi} \\ b e^{-j\varphi} \end{bmatrix} = \begin{bmatrix} b\sqrt{2} \cos \varphi \\ j b\sqrt{2} \sin \varphi \end{bmatrix}$$

for asymmetric branches power division is not equal on the branches

OUTPUT FIELDS ARE IN QUADRATURE, THEIR AMPLITUDE DEPENDS ON THE RELATIVE PHASE OF THE TWO INPUTS

• MMI - MULTIMODE INTERFERENCE COUPLER

N input guides entering a multimodal slab guide

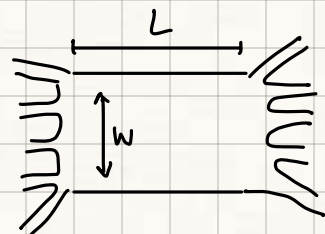

STAR COUPLER

N input and M output ports

N guides that converge in a zone only guided vertically

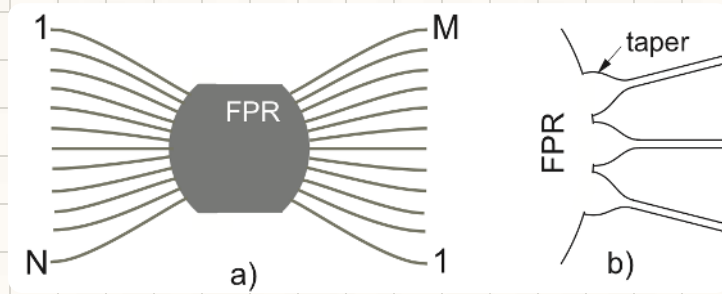
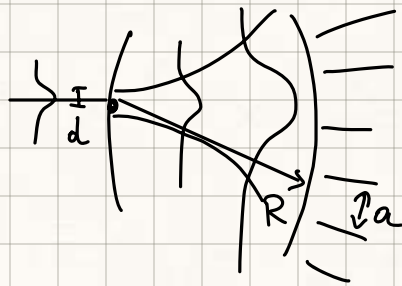

Beam Spot size:

$$W(z) = W_0 \sqrt{1 + \left(\frac{z}{z_R}\right)^2}$$

$$z_R = \frac{\pi W_0^2 \cdot n_{eff}}{\lambda}$$

$$W_0 = \frac{d}{2}$$

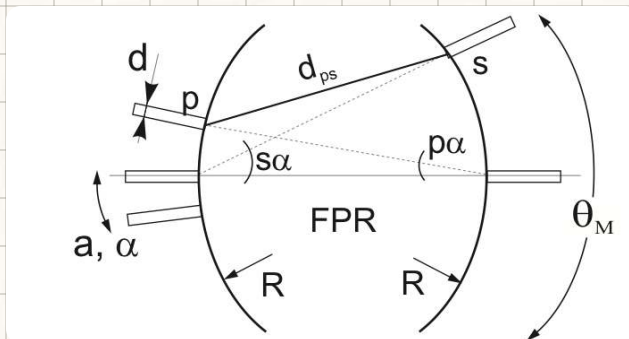

in the central part there's free propagation → FPR Free Propagation Region

M has a limit that depends on input-output distance

$$\hookrightarrow W(z) = M \cdot a$$

we can consider the limit for $W(z)$ when the output field becomes $\frac{1}{e}$



$$R = \frac{M \cdot \pi \cdot n_{eff} \cdot a^2}{2\lambda}$$

TRANSMISSION COEFFICIENT:

$$T_{os} = \frac{\eta}{\sqrt{M}}$$

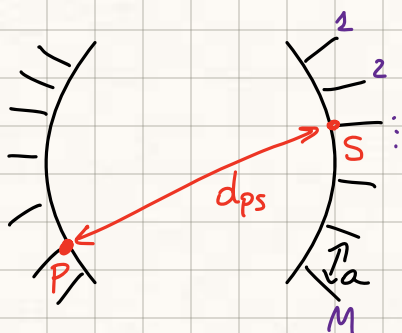

$$T_{ps} = \frac{\eta}{\sqrt{M}} \cdot e^{j\phi_{ps}}$$

PHASE TERM ACCUMULATED BETWEEN PORTS P, S

$$\phi_{ps} = \frac{2\pi}{\lambda} \cdot m_{eff} \cdot d_{ps}$$

$$d_{ps} \cong R(1 - P.S. \cdot \alpha^2), \quad a = \alpha \cdot R$$

transfer function is approximated, going towards the external ports the gaussian is attenuated, while the phase is correct

usually M can be in (10 ~ 100s) range

η AND LOSSES:

η is the efficiency accounting for losses

↳ small reflections where the field does not encounter waveguides

can be seen as a parallel implementation of a FIR filter:

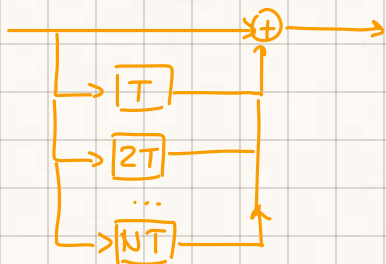

while the cascade of couplers as the series

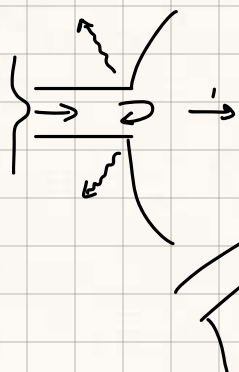

at the output the mode changes, we could get reflections due to impedance mismatch or radiative losses

Additional attenuation comes from the losses at the output "walls"



usually the output is tapered to get a smooth "exit"

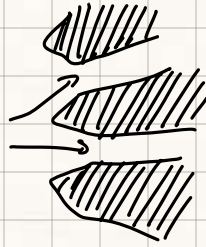

OPTICAL FILTERS

Transfer function depends on FREQUENCY

↳ Passband filter, demux if key can filter, separate unite single channels of a WDM system

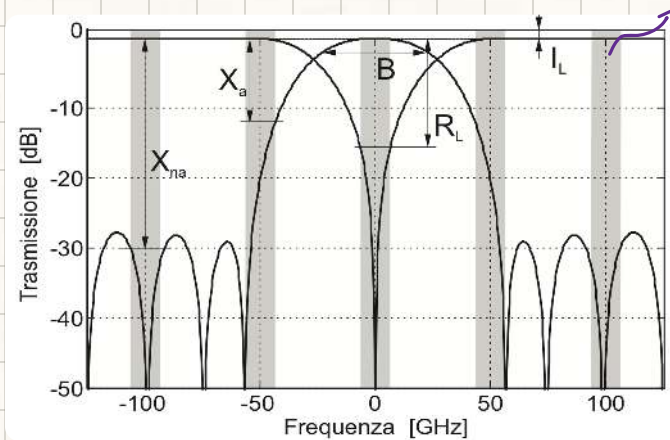
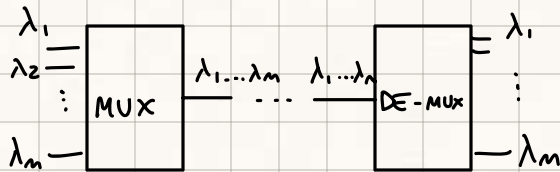

channel band

B: Band (defined at -1 or -3 dB)

I_L: Insertion loss

X_a: out-of-Band Rejection

Passband filter quality characteristics:

- 1) Flat in-band response
- 2) low in-band losses
- 3) low Group delay distortion
- 4) Polarization-insensitive transfer function
- 5) Tuning possibility
- 6) High out-of-band rejection

TYPES OF FILTERS

FIR: $H(f) = \sum_{m=0}^N c_m e^{j\phi_m} e^{-j(2\pi f T)}$ $\rightarrow N=1$

Input signals divided in N parts, recombined with increasing delay

\rightarrow INTERFEROMETERS

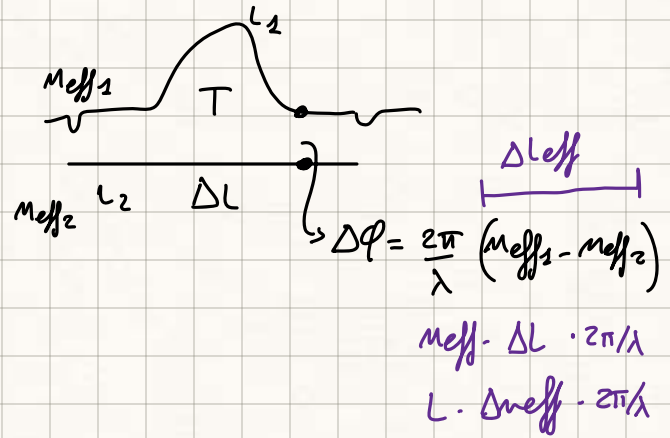

IIR: $H(f) = \left(\sum_{m=0}^N c_m e^{j\phi_m} e^{-j(2\pi f T)} \right)^{-1} \rightarrow$ Infinite replicas
RESONATORS, FABRY PEROT

SPECTRAL CHARACTERISTICS

$\Delta\phi$ determines the interference \rightarrow depends on FREQUENCY AND PATH

$$\Delta\phi = \phi_1 - \phi_2 = \frac{2\pi}{\lambda} (m_{eff1}(\lambda) \cdot L_1 - m_{eff2}(\lambda) \cdot L_2)$$

$\rightarrow 2\pi$ at frequency f_m or λ_m

$$\Delta\phi(f_m) = 2\pi \cdot m = \frac{2\pi}{\lambda} \cdot \Delta L_{eff} \rightarrow \lambda = \frac{\Delta L_{eff}}{m}$$

$$\Delta L_{eff} = m_{1eff} \cdot L_1 - m_{2eff} \cdot L_2$$

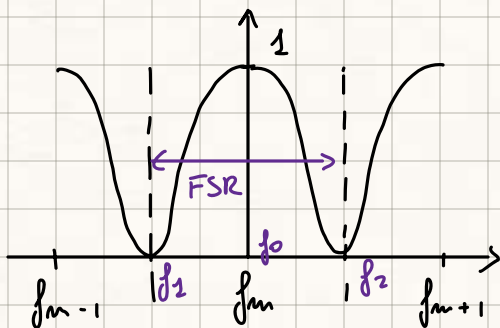

$$FSR = \frac{c}{\Delta L \cdot m_g}$$

$$f_1 = f_0 - \frac{FSR}{2}$$

$$f_2 = f_0 + \frac{FSR}{2}$$

Derivation of FSR:

$$m_g = m_{eff0}(\lambda_0) - \lambda_0 \cdot \left. \frac{dm_{eff}}{d\lambda} \right|_{\lambda_0}$$

$$FSR = \frac{2\pi}{c} \cdot m_{eff2} \cdot f_2 \cdot \Delta L - \frac{2\pi}{c} \cdot m_{eff1} \cdot f_1 \cdot \Delta L$$

$$m_{eff}(f_2) = m_{eff0} - \frac{\partial m_{eff}}{\partial f} \cdot \frac{FSR}{2} \rightarrow f_0 \cdot \frac{\partial m_{eff}}{\partial f} \cdot FSR + m_{eff0} \cdot FSR = \frac{c}{\Delta L}$$

$$\hookrightarrow FSR = \frac{c}{\Delta L \cdot (m_{eff} + f_0 \frac{\partial m_{eff}}{\partial f})} = \frac{c}{\Delta L \cdot n_g}$$

GROUP DELAY: time necessary to the signal to pass the filter

$$\tau_g = - \frac{\partial \varphi(\omega)}{\partial \omega} = \frac{\lambda^2}{2\pi c} \cdot \frac{\partial \varphi(\omega)}{\partial \omega}$$

DISPERSION: nonlinear response in frequency

$$D = \frac{\partial \tau_g}{\partial \omega}$$

MACH ZENDER:

Sinusoidal transfer function

TRANSFER FUNCTION OF MZ:

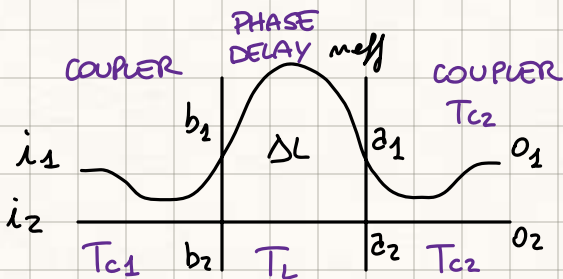

$$\begin{bmatrix} o_1 \\ o_2 \end{bmatrix} = T_{c2} \begin{bmatrix} a_1 \\ a_2 \end{bmatrix} = T_{c2} \cdot T_L \begin{bmatrix} b_1 \\ b_2 \end{bmatrix} = \overbrace{T_{c2} \cdot T_L \cdot T_{c1}}^{T_{MZ}} \begin{bmatrix} i_1 \\ i_2 \end{bmatrix}$$

$$T_c = \begin{bmatrix} \cos(k \cdot L_c) & -j \sin(k \cdot L_c) \\ -j \sin(k \cdot L_c) & \cos(k \cdot L_c) \end{bmatrix}$$

$$T_L = e^{-j \varphi_L} \begin{bmatrix} 1 & 0 \\ 0 & e^{j \Delta \varphi_L} \end{bmatrix}$$

$$\Delta\phi_L = \frac{2\pi}{\lambda} \cdot \Delta \cdot L_{\text{eff}} = \beta_1 L_1 - \beta_2 L_2$$

3dB COUPLERS: $T_{c1} = T_{c2} = T_c = \frac{1}{\sqrt{2}} \begin{bmatrix} 1 & -j \\ -j & 1 \end{bmatrix}$

$$T_{Mz} = -j e^{j \frac{\Delta\phi}{2}} \begin{bmatrix} \sin\left(\frac{\Delta\phi}{2}\right) & \cos\left(\frac{\Delta\phi}{2}\right) \\ \cos\left(\frac{\Delta\phi}{2}\right) & -\sin\left(\frac{\Delta\phi}{2}\right) \end{bmatrix} \quad (\text{neglecting losses, 3dB couplers})$$

Everything depends on $\Delta\phi$, behavior can be set changing ΔM or ΔL

$$P_{\text{bar}} = |T_{11}|^2 = \cos^2\left(\frac{\Delta\phi_L}{2}\right) \underbrace{\cos^2(2\kappa \cdot L_c)}_{\substack{\text{coupling} \\ \text{coefficient, coupling length}}} + \sin^2\left(\frac{\Delta\phi_L}{2}\right)$$

$$P_{\text{cross}} = |T_{21}|^2 = \cos^2\left(\frac{\Delta\phi_L}{2}\right) \sin^2(2\kappa \cdot L_c)$$

Coupling coefficients, losses make it impossible for P_{cross} to arrive to 1

↳ directional couplers are responsible for the spectral response

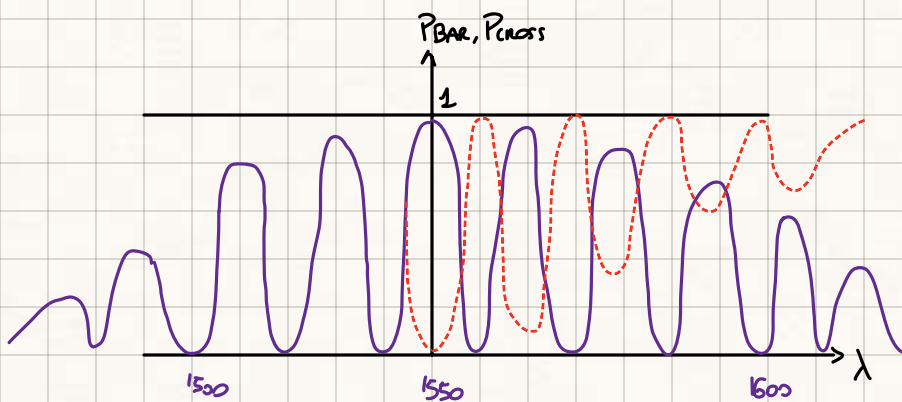

coupling depends on λ , degrades going away from the central wavelength

FOR SYNCH MZ, NO LOSSES:

$$P_{\text{bar}} = \sin^2\left(\frac{\Delta\phi_L}{2}\right)$$

$$P_{\text{cross}} = \cos^2\left(\frac{\Delta\phi_L}{2}\right)$$

• DIMENSIONING A MZ:

assume to have 2 wavelength:

$$\lambda_1 = 1550 \text{ nm}$$

$$\lambda_2 = \lambda_1 + 100 \text{ GHz}$$

$$n_{\text{eff}} = 1,46$$

$$n_g = 1,51$$

we want to combine them together, use a technology with $n_{\text{eff}} = 1,46$, $n_g = 1,51$

we need an unbalanced MZ, a filter

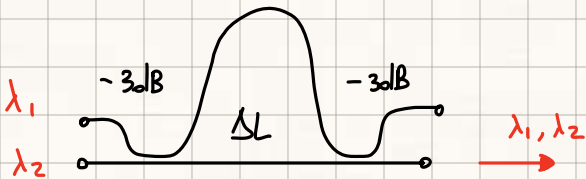

$$\lambda_2: \frac{\Delta \lambda}{\lambda} = -\frac{\Delta f}{f} \rightarrow \Delta \lambda = -\frac{\lambda^2}{c} \cdot \Delta f = 0,80124 \cdot 10^{-9} \text{ m} \rightarrow \lambda_2 = 1550,80124 \text{ nm}$$

1) objectives: $P_{\text{bar}}(\lambda_1) = 0$

$$P_{\text{BAR}} = \sin^2\left(\frac{\Delta \phi}{2}\right)$$

$$P_{\text{cross}} = \cos^2\left(\frac{\Delta \phi}{2}\right)$$



if we impose that P_{BAR} is zero for λ_1 then

$$\Delta \phi = \frac{2\pi}{\lambda} \cdot n_{\text{eff}} \cdot \Delta L (+ 2M\pi)$$

$$2) \text{ FSR} = \frac{c}{n_g \cdot \Delta L} = 2 \cdot (\lambda_2 - \lambda_1) = 2 \cdot \Delta \lambda = 200 \text{ GHz}$$

$$3) \text{ Calculate } \Delta L = \frac{c}{\text{FSR} \cdot n_g} = 993,377 \mu\text{m}$$

4) Verify WHERE IS THE TRANSFER FUNCTION:

$$\frac{\Delta \phi}{2} = N \cdot \pi = \frac{1}{2} \cdot \frac{2\pi}{\lambda_1} \cdot n_{\text{eff}} \cdot \Delta L \rightarrow N = \frac{n_{\text{eff}} \cdot \Delta L}{\lambda_1} = 935,6 \text{ N}$$

WE NEED TO ROUND TO THE NEXT INTEGER

5) we round to $N = 936$ and evaluate the new ΔL

$$\Delta L' = \frac{N \cdot \lambda_1}{m_{\text{eff}}} = 993,698 \mu\text{m}$$

$$\text{FSR}' = \frac{c}{m_g \cdot \Delta L'} = 199,935 \text{ GHz}$$

$\Delta \text{FSR} = 65 \text{ MHz}$ over $200 \text{ GHz} \rightarrow$ acceptable

6) CHECK FOR λ_2 !

$$\frac{\phi_2}{2} = \frac{1}{2} \cdot \frac{2\pi}{\lambda_2} \cdot m_{\text{eff}} \cdot \Delta L' = \frac{\pi}{1550,80124 \cdot 10^{-9}} \cdot 1,46 \cdot 993,698 \cdot 10^{-6} = 2,939 \cdot 10^3$$

$$P_{\text{cross}}(\lambda_2) = \cos^2\left(\frac{\Delta\phi}{2}\right) = \sin^2\left(\frac{2\pi}{\lambda_2} \cdot m_{\text{eff}} \cdot \Delta L'\right) = -26 \text{ dB} \checkmark$$

$$P_{\text{bar}}(\lambda_2) = \sin^2\left(\frac{\Delta\phi}{2}\right) = -0,01 \text{ dB}$$

• MZ with added geometrical unbalance

↳ INDUCED Δm_{eff} :

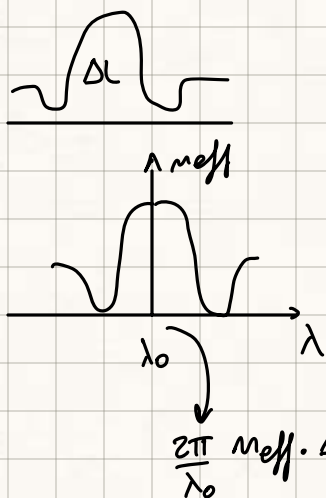

we change temperature to the whole chip

↳ the refractive index changes as

$$m_{\text{eff}} = m_{\text{eff}0} + \Delta m \rightarrow \Delta T, \text{ aging, stress, ...}$$

CHANGE IN TRANSFER FUNCTION:

$$\lambda_0 = \frac{m_{\text{eff}} \cdot \Delta L}{N} \rightarrow \lambda_0' = \frac{m_{\text{eff}} \cdot \Delta L}{N} + \frac{\delta m \cdot \Delta L}{N}$$

$$\frac{\Delta \lambda}{\lambda} = \frac{\Delta m_{\text{eff}}}{m_{\text{eff}}} = \frac{\delta \Delta L}{\Delta L}$$

$$\delta m = \frac{\Delta f}{f_0} \cdot m_{\text{eff}}$$

shift on the transfer function means a shift on the effective index



↳ shift len acceptable for low FSR

EX: $FSR = 200 \text{ GHz}$ $f_0 = 200 \text{ THz}$

$$\delta m_{FSR} = \frac{FSR}{f_0} \cdot m_{\text{eff}}|_{\text{Si}} = \frac{200 \text{ THz}}{200 \cdot 10^{12}} \cdot 3,5 = 3,5 \cdot 10^{-3}$$

PRECISION IN THE FABRICATION Δm :

we calculate $\delta m|_{FSR}$ and decide from there

↳ we apply the shift and recalculate P_{low} , P_{cross}

$$\hookrightarrow \Delta \varphi_{FSR + \delta m} = \frac{2\pi}{\Delta FSR} \rightarrow \cos^2\left(\frac{1}{2} \cdot \frac{2\pi}{10}\right) = 0,995$$

let's say we move by $\delta m \rightarrow \frac{FSR}{10}$ $\sin^2\left(\frac{1}{2} \cdot \frac{2\pi}{10}\right) \approx -10 \text{ dB}$ NOT ACCEPTABLE

we decide for $\sin^2\left(\frac{1}{2} \cdot \frac{2\pi}{\delta FSR}\right) = -25 \text{ dB}$

WE SET $\sim (-25 \text{ dB})$ at the P_{cross} and then calculate accuracy

$$-25 = 0,00316 = \sin^2(x) \quad x = \sin^{-1}\left(\sqrt{0,00316}\right) = 0,05624$$

$$x = \frac{1}{2} \frac{2\pi}{\delta m / \delta m_{FSR}} \rightarrow \delta = \frac{\pi}{x} = 55$$

we can tolerate $\Delta \varphi = \frac{2\pi}{55} \rightarrow \delta m = \frac{\delta m_{FSR}}{55}$

$$\delta \Delta L = 1\lambda \rightarrow \Delta \phi = 2\pi$$

we need to control ΔL by a value $\delta \Delta L = \frac{2\pi}{\frac{\delta m}{\delta m_{FSR}}}$

- TO INCREASE THE ORDER OF THE FILTER WE CAN COMBINE MULTIPLE MZs :

MACH-ZENDER IN CASCADE

we have a product of the single transfer functions

we increase selectivity and reduce FSR by adding harmonics

↳ passband shape is not flat

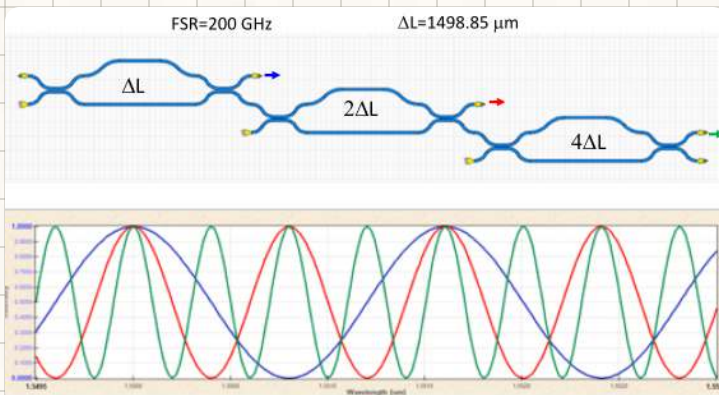

Sum of all the harmonics

good for selective filters for a single channel

↳ but loses all other channels

Transfer function is rather RIGID

Bandwidth decreases at every step $\rightarrow P_{\text{bar}} = \sin^{2N} \left(\frac{\Delta \phi_L}{2} \right)$

not suitable for MULTIPLEXING:

we use this scheme

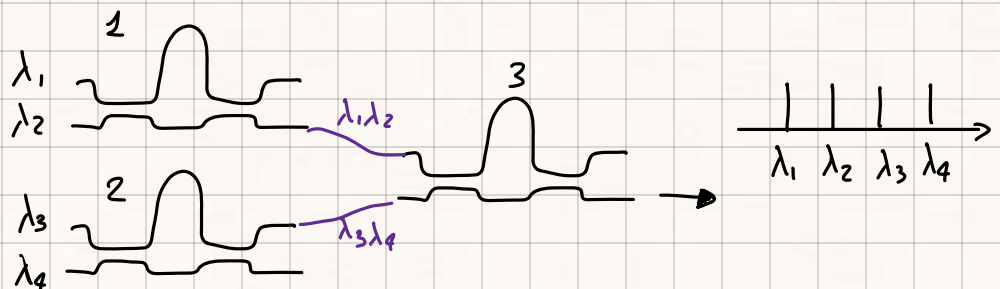

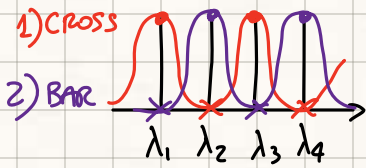

how much is the unbalance? \rightarrow we design ΔL for the first stage and then the second stage has $\frac{FSR_1}{2} \rightarrow$ use $2\Delta L$

MACH ZENDER IN SERIES

LOW LOSSES IN PASSBAND

All the phase shifters are identical.

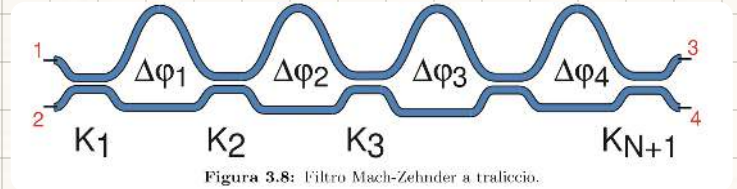

increasing the stages we can better approximate the objective function

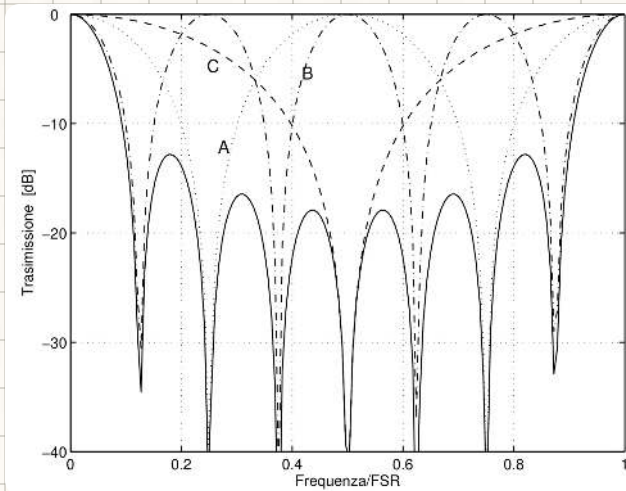

\rightarrow Function of the single stages

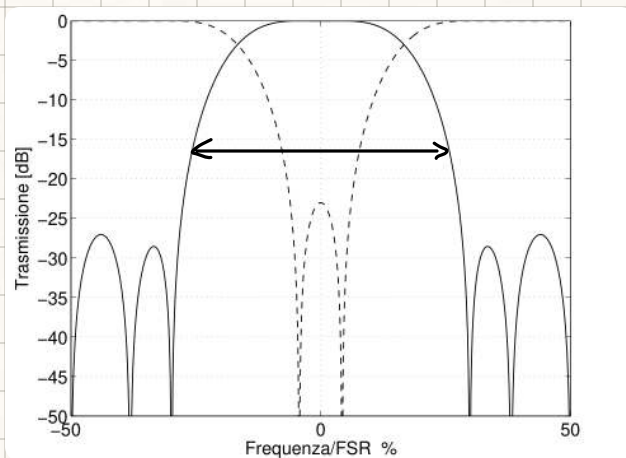

\rightarrow Response of the filter (order $N=7$)

$$\frac{\text{Band}}{\text{FSR}} = 20\%$$

good to realize a flat-top bandpass filter, selectivity is not great but it's robust for tolerances,

ADD-DROP MULTIPLEXER can be realised this way

PHASES - ARRAY (DEMULTIPLEXER)

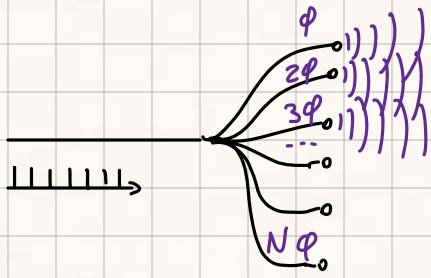

$$\cdot \sum a_i e^{j\phi_i} \cdot e^{j\phi_i}$$

starting phase

propagation phase (different for everyone)

at this point we get constructive interference (fronts arrive in phase)

depending on ϕ we can choose the point where all the contributions arrive in phase and give the maximum

if $\phi = \frac{2\pi}{\lambda} n_{\text{eff}} \cdot L$ \rightarrow changing λ we obtain different ϕ

the various wavelengths accumulate at different points of this device

\hookrightarrow we **SPATIALLY DEMULTIPLEX THE CHANNEL WHEN WE ARE IN FAR FIELD**

ARRAY WAVEGUIDE GRATINGS - AWG

implement an FIR filter

composed of: $\underbrace{2 \text{ STAR COUPLERS}}_{N \times M + M \times N} + \text{ARRAY OF GUIDES}$

every guide has an optical path longer by ΔL from the precedent

TRANSFER FUNCTION OF THE AWG

output field at generic port 'q' entering from 'p', passing from 's'

↳ signal enters the star coupler → divides power onto M central guides

each central guide adds a different phase shift

At the second s.c. the signals are recombined

- consider only s^{th} central guide

$$E_{qsp} = \frac{1}{\sqrt{M}} \cdot e^{j\phi_{ps}} \cdot e^{j\phi_s} \cdot \frac{1}{\sqrt{M}} \cdot e^{j\phi_{sq}} \quad \text{3 phase contributions}$$

phase shift of the single waveguide s :

$$\phi_s = \frac{2\pi}{\lambda} \cdot n_{\text{eff}} \cdot (L_0 + s \cdot \Delta L)$$

Distance between 'p' and 's' :

$$d_{ps} = R(1 - ps \cdot \alpha^2)$$

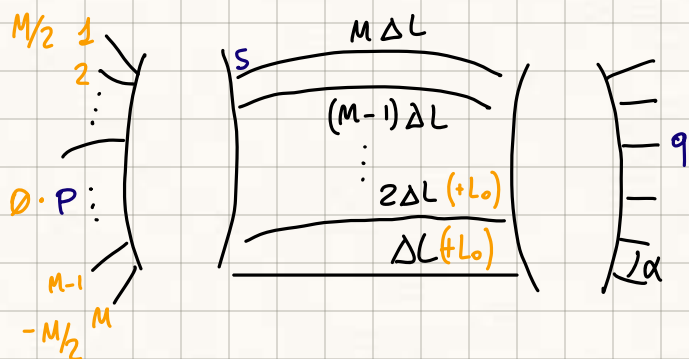

- TOTAL OUTPUT = SUM OF ALL CONTRIBUTES

$$E_{pq} = \sum_{s=0}^{M-1} E_{qsp} = \frac{1}{M} \cdot \sum_{s=0}^{M-1} e^{js \cdot \Delta\phi_{pq}}$$

↳ s. (shift between adjacent waveguides)

$$\Delta\phi_{pq} = \frac{2\pi}{\lambda} \cdot m_{\text{eff}} \cdot [\Delta L - R(p+q)\alpha^2]$$

INTENSITY TRANSFER FUNCTION:

$$T_{pq} = |E_{pq}|^2 = \frac{1}{M^2} \frac{\sin^2\left(M \cdot \frac{\Delta\phi_{pq}}{2}\right)}{\sin^2\left(\frac{\Delta\phi_{pq}}{2}\right)}$$

in the phase term we consider contributions from the onay and star couplers.

Numerator oscillates much faster.

CHANNEL SEPARATION AND FSR:

when $\Delta\phi_{pq} = \frac{\pi}{2} \cdot Q$ (Q integer)

↳ $T_{pq} = \frac{1}{M^2} \frac{\sin^2(Q \cdot M \cdot \pi/2)}{\sin^2(Q \cdot \pi/2)} = 1$ we have COMPLETE TRANSFER FROM PORT 'p' TO 'q'

we get output only in port q

this happens for $\lambda_{pq} = \frac{m_{\text{eff}} \cdot \Delta L}{Q} - m_{\text{eff}} \cdot R(p+q) \frac{\alpha^2}{Q}$

$$= \lambda_0 - (p+q) \Delta\lambda$$

($p, q = 0$)

at each wavelength we get a different transfer function

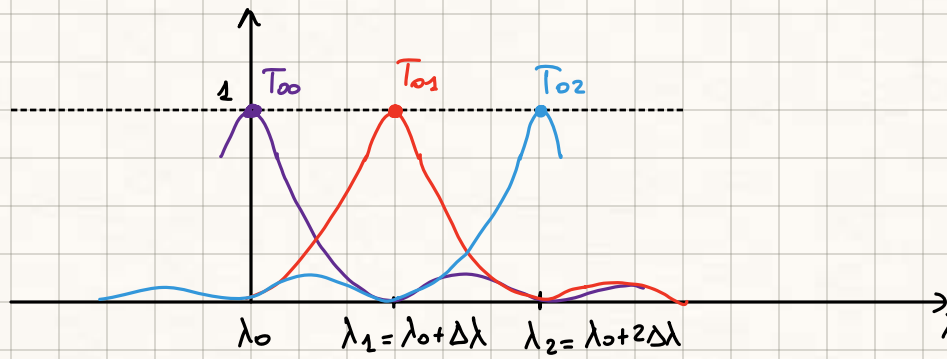
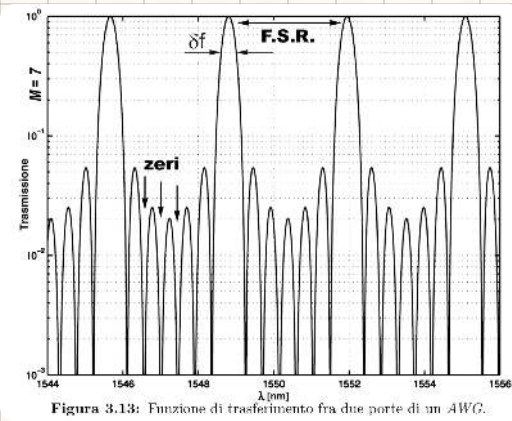

- Periodicity (Free Spectral Range) depends on ΔL

$$FSR = \frac{c}{m \cdot \Delta L}$$

- Crosstalk rejection:

increasing M we increase the n° of lateral peaks

reducing their amplitude \rightarrow PROBLEM: transmission peak gets smaller

TRANSMISSION LOBE:

$$\delta f = \frac{FSR}{M}$$

this also means that we need to control temperature, Δm , $\Delta \lambda$...

M TIMES BETTER THAN A MZ

AWG DIMENSIONING:

- Known data: typically
 - N_{ch} number of channels
 - m_{eff}
 - λ_0
 - Δf channel spacing

- Dimensioning:

we calculate Q which determines ΔL , then we choose M based on XTALK then we dimension the star couplers choosing R, d

• EXAMPLE :

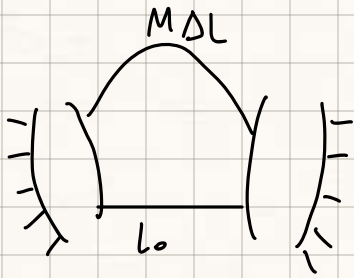

$$N_{ch} = 8$$

$$\text{SiO}_2 \quad n_{eff} = 1,45$$

$$n_g = 1,5$$

$$L_0 = 1550 \text{ mm}$$

$$d = 5 \mu\text{m}$$

$$\Delta f = 100 \text{ GHz} \rightarrow \text{spacing of the channel}$$

bandwidth of the signal: $B = 28 \text{ GHz}$ (DQPSK, 40 Gbit/s)

1) calculate FSR = $8 \cdot 100 \text{ GHz} = 800 \text{ GHz}$ (6,4 mm)



$$\frac{100 \text{ GHz}}{125} \approx \frac{0,8 \text{ mm}}{1}$$

$$\text{FSR} = \frac{c}{n_g \cdot \Delta L} \rightarrow \text{determine } \Delta L = 250 \mu\text{m}$$

2) position of transfer function: $\lambda_0 = \frac{n_{eff} \cdot \Delta L}{Q} = 1550 \text{ nm}$

$$Q = 233,87$$

not integer, then it doesn't pass for $\lambda_0 \rightarrow Q = 234$

$$\text{new } \Delta L = 250,130 \mu\text{m}$$

now channel 0 is correctly transferred to the output

$$\text{FSR} = 799,564 \text{ GHz} \quad (400 \text{ MHz difference, negligible)}$$

3) calculate how many waveguides in the ARRAY, M:

$$M \leq \frac{\text{FSR}}{B} = 28,56$$

we get a main lobe with -3dB bandwidth = 28
going higher we reduce the bandwidth

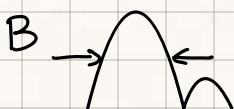

shifting the filter we have losses

using less waveguides we get a longer filter, good when cascading filters to avoid distortion and losses

Reducing too much the main lobe increases, but also lateral ones introduce contributions of crosstalk from the other channels

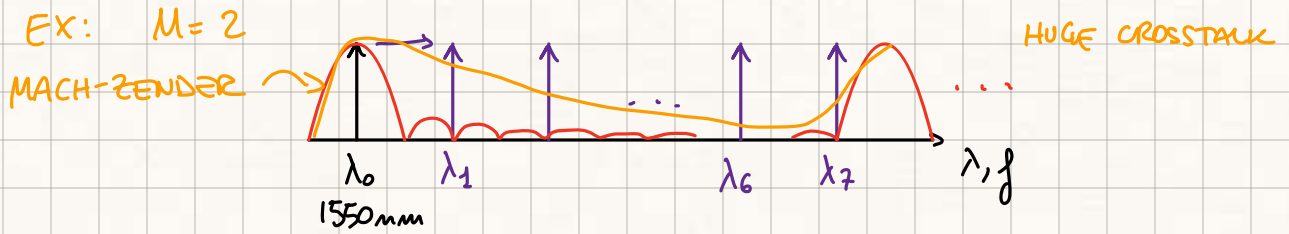

4) Design star coupler, $\Delta\lambda$:

$$\Delta\lambda = m_g R \frac{\alpha^2}{Q} = m_g \cdot \frac{\alpha^2}{Q} \cdot \frac{1}{R}$$

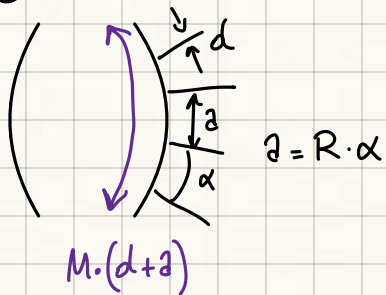

if α is large the response is good but we have more losses
while when too close together the guides are coupled

first assumption: $\alpha \geq 3 \cdot d = 15 \mu\text{m}$

$$M \cdot (d+a) = 28 (20 \cdot 10^{-6}) = 560 \mu\text{m} \rightarrow R = \frac{m_g \alpha^2}{Q \cdot \Delta\lambda} =$$

$$R = \frac{m_g \cdot \alpha^2}{Q \cdot \Delta\lambda} = \frac{1,5 \cdot (15 \cdot 10^{-6})^2}{234 \cdot 0,8 \cdot 10^{-3}} = 1,8 \text{ mm}$$

DONE \rightarrow

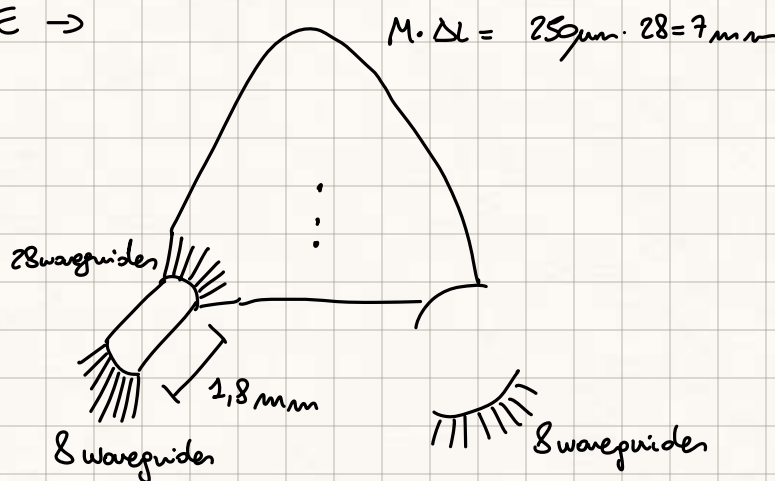

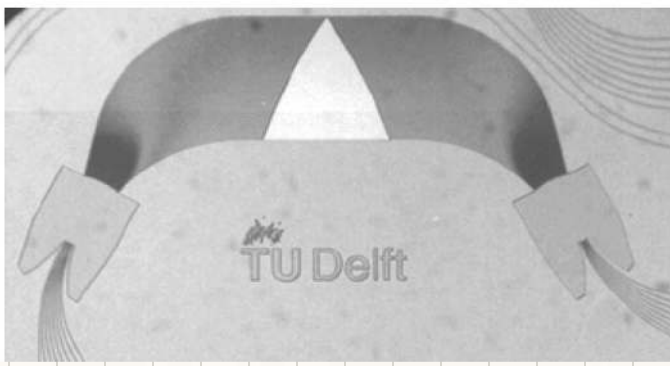

The triangle is related to a polarization rotation to respect

$$\Delta L \cdot n_{\text{effTE}} = \Delta L \cdot n_{\text{effTM}}$$

$$\text{TE: } \frac{\Delta L}{2} n_{\text{effTE}} + \frac{\Delta L}{2} n_{\text{effTM}} = \Delta \phi_{\text{TE}}$$

$$\text{TM: } \frac{\Delta L}{2} n_{\text{effTM}} + \frac{\Delta L}{2} n_{\text{effTE}} = \Delta \phi_{\text{TM}}$$

to be balanced for any birefringence

Phase errors at the input result in higher levels of crosstalk

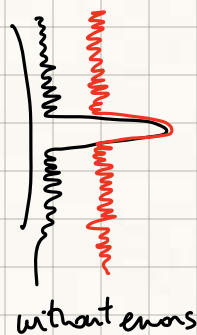

RING RESONATORS

IIR filter it's a resonator, like a Fabry-Perot

• FILTER

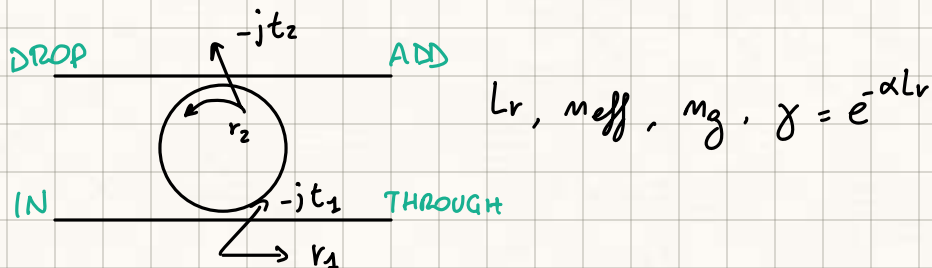

• PHASE SHIFTER

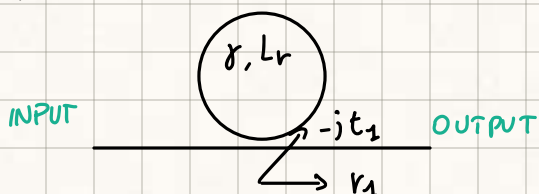

in general the two directional couplers are different:

$$\begin{bmatrix} r_1 & -jt_1 \\ -jt_1 & r_1 \end{bmatrix}$$

transfer function TO PORT 'ADD' IS 0

OPTICAL FILTER:

BEHAVIOUR: if the input signal's frequency is one of the ring's resonant frequencies signal goes to 'DROP' part, otherwise it goes to 'THROUGH'

↳ we can use the 'ADD' port to insert back a signal at resonant frequency

TRANSFER FUNCTION:

obtained by cascading the matrices of the blocks

or consider the input-output relations at each port

• THROUGH PORT:

$$H_t = r_1 - \underbrace{j t_1 \cdot \gamma \cdot e^{-j\beta L r} \cdot r_2 \cdot (-j t_1) + \dots}_{\substack{\text{Round trip losses} \\ \text{upper directional coupler}}} \cdot r_1 e^{j\beta L r} \dots \leftarrow \text{obtained by entering,} \\ \text{going around the ring} \\ \text{and going through}$$

$$= r_1 - \gamma r_2 \cdot t_1^2 e^{-j\beta L r} (1 + r_1 r_2 \gamma e^{-j\beta L r} + \dots) =$$

$$= \frac{r_1 - \gamma r_2 e^{-j\beta L r}}{1 - r_1 r_2 \gamma e^{-j\beta L r}} = \frac{r - r e^{-j\beta L r}}{1 - r^2 e^{-j\beta L r}} \quad \begin{matrix} r_1 = r_2 \\ \gamma = 1 \end{matrix}$$

↳ in the through port we have a pole in the zero

$$\beta = \frac{2\pi}{\lambda} \cdot m_{\text{eff}}$$

• ADD PORT:

$$H_a = 0$$

• DROP PORT:

$$H_d = 1 - H_t = \frac{-t_1 t_2 \sqrt{\gamma} \cdot e^{-j\beta L r / 2}}{1 - \gamma r_1 r_2 e^{-j\beta L r}}$$

RESONANCE CONDITION:

in the through port we have a pole in the zero

$$\text{if } e^{-j\beta L r} = 1 \rightarrow H_t = 0, H_d = 1$$

$$\beta L r = 2\pi \cdot N$$

- input signal is sent to the drop port entirely and through is isolated only if $r_1 = \gamma r_2$
- insertion losses in through are low while the drop ones are amplified (light is stuck in the loop)

FSR:

Transfer function is periodical of period

$$FSR = \frac{c}{m_g \cdot L_r}$$

ANTIRESONANCE:

$$\beta L_r = \frac{2\pi}{\lambda} \cdot m_{eff} \cdot L_r = 2\pi \cdot N + \pi \quad \rightarrow \quad \lambda_N = \frac{m_{eff} \cdot L_r}{N}$$

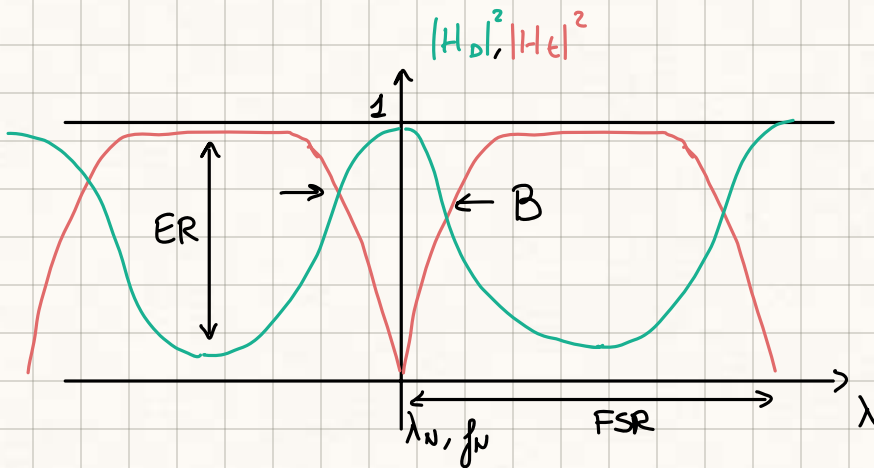

3dB BANDWIDTH:

in case of identical couplers : $t_i^2 = K$, no losses

$$B = \frac{FSR}{\pi} \cdot \frac{K}{\sqrt{1-K}}$$

EXTINCTION RATIO:

Ratio of $\frac{\text{Hd resonance}}{\text{Hd antiresonance}}$

$$ER = \frac{(k-2)^2}{k^2}$$

Bandwidth is a function of FSR. It can be changed adjusting coupling coefficients

↳ decreasing the coefficients: ER INCREASES
B DECREASES

PHASE TRANSFER FUNCTION:
(Phase response)

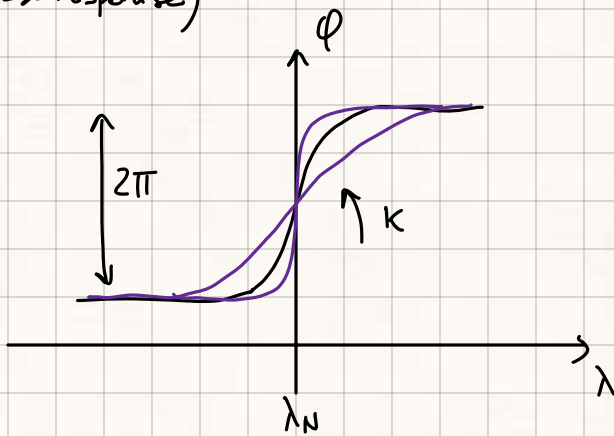

↑
Phase response is not linear

GROUP DELAY TRANSFER FUNCTION:

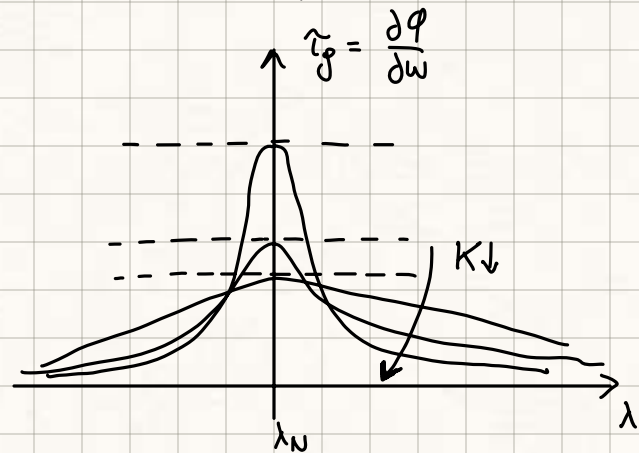

we can use the higher delay to make a DELAY LINE
the delay value depends on how many round
trips are made in the ring:

T.F

↳ Finesse

FINESSE:

$$F = \frac{FSR}{B}$$

gives immediate idea of the selectivity

also gives the group delay as: $\tau_g = F \cdot \tau$ \rightarrow RTT TIME

$F = R\tau_{\text{average}} \rightarrow$ An extremely high finesse means high efficiency but very slow response

The intensity inside the ring is F times longer than the input power

\hookrightarrow could lead to problems/advantages in case of nonlinearities

Q FACTOR:

$$Q = \omega_0 \cdot \frac{\text{Energy stored in resonator}}{\text{Power loss by the cavity}} = \frac{f_0}{B}$$

INSERTION LOSS:

$$IL \approx F \cdot e^{-\alpha L r}$$

- How well do we have to control the temperature (physical length, refractive index) of the ring resonator?

we provide $\Delta\varphi = 2\pi$ the transfer function shifts by 1 FSR

\hookrightarrow we accept a shift $\ll B$ ($\frac{1}{2}, \frac{1}{10}, \dots$ depending on requirements)

Phase must be controlled by $\Delta\varphi \ll \frac{2\pi}{F}$

$$\Delta\varphi = \frac{2\pi}{\lambda} \Delta n_{\text{eff}} \cdot L r$$

$\Delta n_{\text{eff}} = K_{\text{TOC}} \cdot \Delta T \rightarrow \Delta T$ should be F times smaller than in a MZ

EX: WDM SYSTEM

$$\# \text{channels} = 100$$

$$\text{Channel spacing } \Delta f = 100 \text{ GHz}$$

bitrate 40 Gbit/s \rightarrow signal's bandwidth is 30 GHz

we want A FILTER TO SELECT ONE CHANNEL:

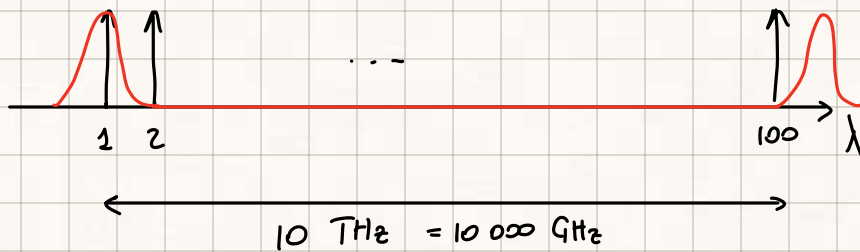

$$\text{Filter: } F = \frac{10000 \text{ GHz}}{30 \text{ GHz}} = 333$$

coupling coefficient K : $F = \frac{\pi \sqrt{1-K}}{K} \rightarrow$ from this get the gap between waveguides to build the filter

$$\text{then } \frac{\Delta f}{f} = \frac{\Delta n_{\text{eff}}}{n_g}$$

$\hookrightarrow 200 \text{ THz}$

SMALL $K \rightarrow$ HIGH FINESSE
slow response time

$$\text{we accept } \Delta f = 2 \text{ GHz} \rightarrow \frac{\Delta f}{f} = 10^{-5}$$

then we can accept a $\Delta T \leq 0,1^\circ \text{C}$

$$\Delta \varphi = \frac{2\pi}{\lambda} \cdot \Delta n_{\text{eff}} \cdot L_r = \frac{2\pi}{\lambda} \cdot L_r \cdot K_{\text{TOC}} \cdot \Delta T$$

\hookrightarrow Thermo-optic coefficient

RING PHASE SHIFTER:

Phase shifter is an ALLPASS FILTER

$$T(\omega) = \frac{r - \gamma e^{-j\beta \cdot Lr}}{1 - \gamma r \cdot e^{-j\beta Lr}}$$

Phase shift is NONLINEAR in frequency

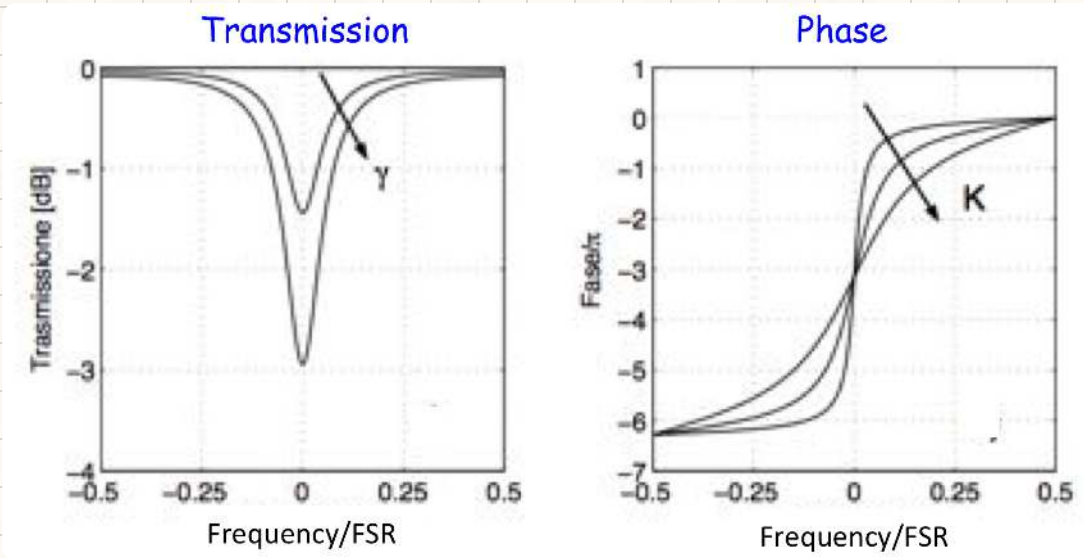

Increasing γ the transfer function goes away from 1 \rightarrow beam stays in the ring at resonance and gets attenuated

BACK SCATTERING IN RING RESONATORS:

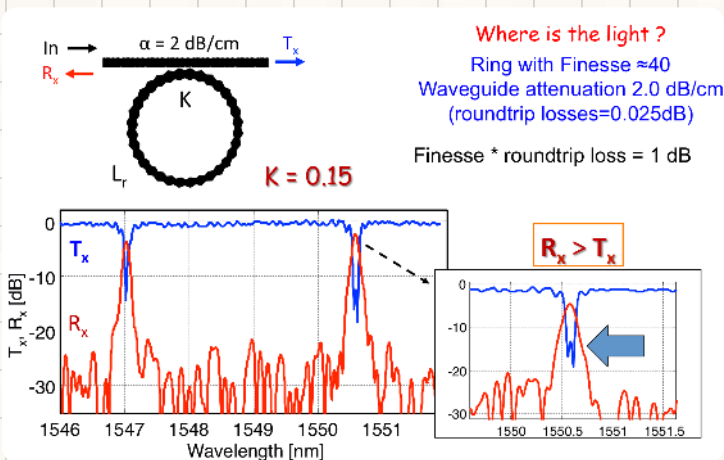

scattering losses given by the ROUGHNESS OF THE WAVEGUIDE

\rightarrow Notch splitting is caused by the clockwise and counter-clockwise modes that get coupled together in a random way
 \hookrightarrow sometimes notch splitting is not present

STRAIGHT WAVEGUIDE:

backscatter is a random white noise ~ -20 dB

RING WITH LARGE COUPLING COEFFICIENTS:

we see losses where the resonance are

↳ become higher for lower resonance

they become longer than the transmitted power for resonant frequencies

↳ as a reflection

BENDING RADIUS AND FSR

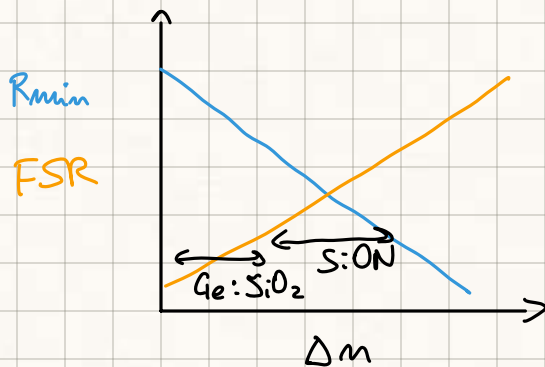

$$FSR = \frac{c}{n_g \cdot 2\pi R} \approx 29 \cdot \Delta n g^{1,5} \text{ [nm]}$$

$$R_{min} \approx 5 \cdot \Delta n^{-1,5}$$

for higher Δn we can decrease the dimension of the ring

Glon on silicon, $\Delta n \sim 10^{-2}$, low FSR and high $R_{min} \approx \text{cm}$

Silicon photonics $R_{min} \sim \mu\text{m}$

COUPLED CAVITIES

we can shape the transfer function to have a flat transmission and high rejection

↳ we cascade all poles in the drop

DIRECT BANDPASS

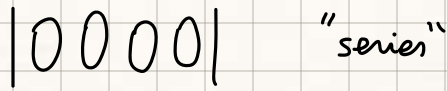

PARALLEL BANDSTOP



MZ + RING → allows to shape the TF as we want

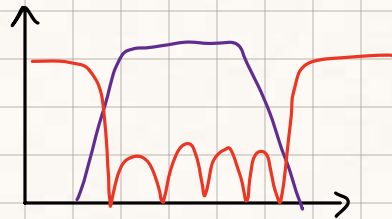
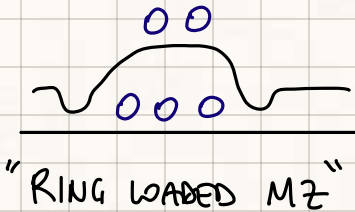

$$TF_{MZ} = \cos^2\left(\frac{\Delta\phi}{2}\right)$$

$$\Delta\phi_{MZ} = \frac{2\pi}{\lambda} n_{eff} \cdot \Delta L$$

↳ ring can change the PHASE NONLINEARLY and shape ANY RESPONSE

TUNABLE BANDWIDTH FILTER:

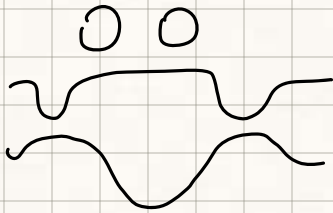

change resonant frequency of the two rings we change the transfer function and it's bandwidth

↳ it would be difficult to change B in a ring (K)

we get a TUNABLE RESPONSE

TUNABLE FSR

given by the imbalance and the group index

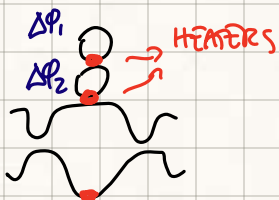

we change the phase very rapidly and the FSR is much smaller

when coupling cavities we cannot put together a lot of them

↳ IMPEDANCE MATCHING PROBLEM

match something depending on n_{eff} with $n_g \rightarrow$ reflections

(characteristic impedance depends on n_{eff} for the waveguide
 n_g for the cavities)

spurious spectral response

↳ we need to change the K of each component

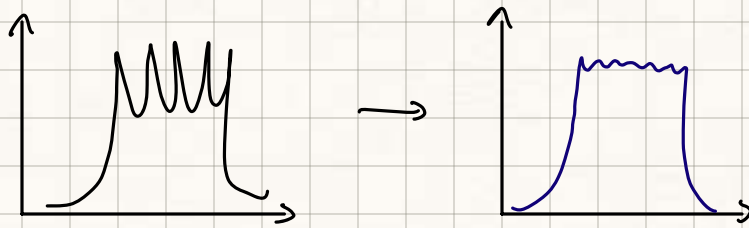

RING-BASED ROUTER:

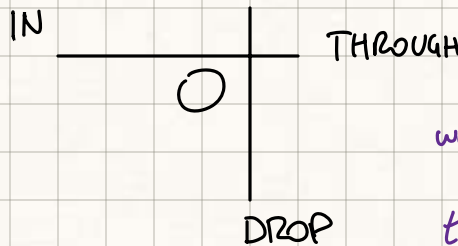
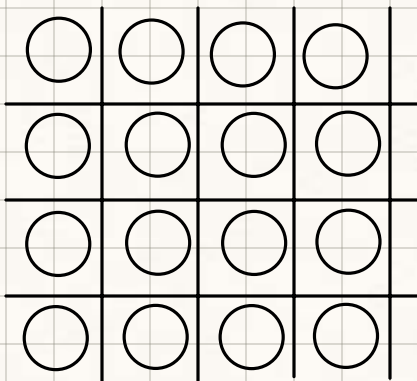

we can use more rings in a node to shape the transfer function

SINGLE CHANNEL ADD-DROP

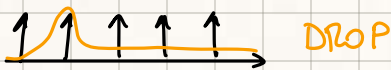

DROP

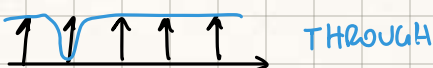

THROUGH

$FSR = N \cdot \Delta\lambda$

parallel configuration

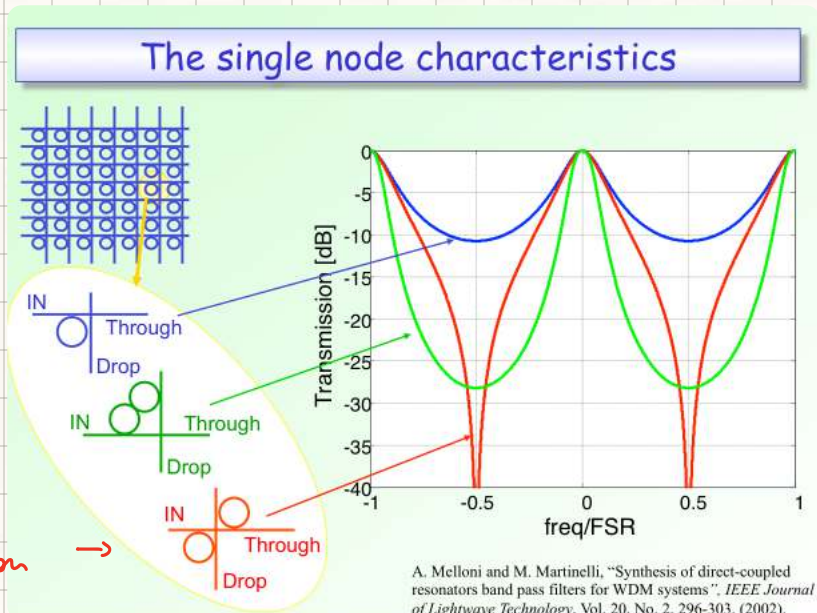

A. Melloni and M. Martinelli, "Synthesis of direct-coupled resonators band pass filters for WDM systems", *IEEE Journal of Lightwave Technology*, Vol. 20, No. 2, 296-303, (2002).

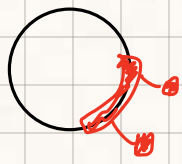

each ring has on heater and we can change the resonant frequency

ALL DROP: $FSR = \Delta\lambda$

DROP or put the ring in ANTIRESONANCE, all goes through

RING-BASED DEMUX/MUX:

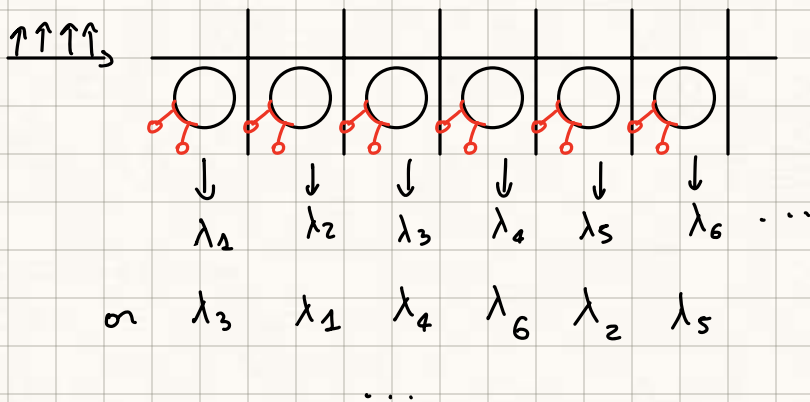

→ all the in-out relations are CONFIGURABLE

while in an AWG is fixed

CROSS CONNECT :

$FSR = \Delta\lambda$

ADD

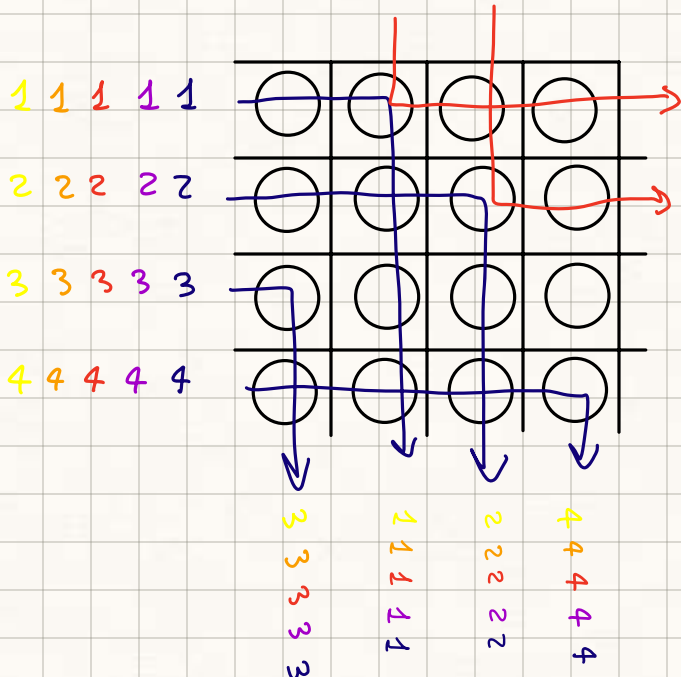

DEMUX → AWG : $FSR = N \cdot \Delta\lambda$
color-based

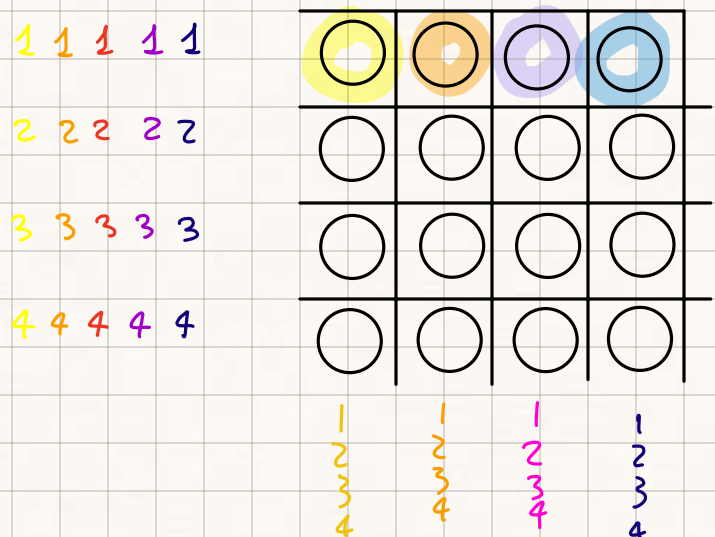

PROBLEM: thermal XTALX, we don't know the resonant frequency precisely

K of the ring determines node's transfer function

↳ small K means high selectivity but small BANDWIDTH

ISI vs crosstalk tradeoff

Trade off between intersymbol interference (ISI) and cross-talk

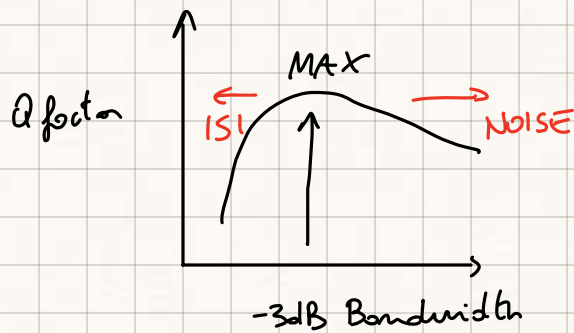
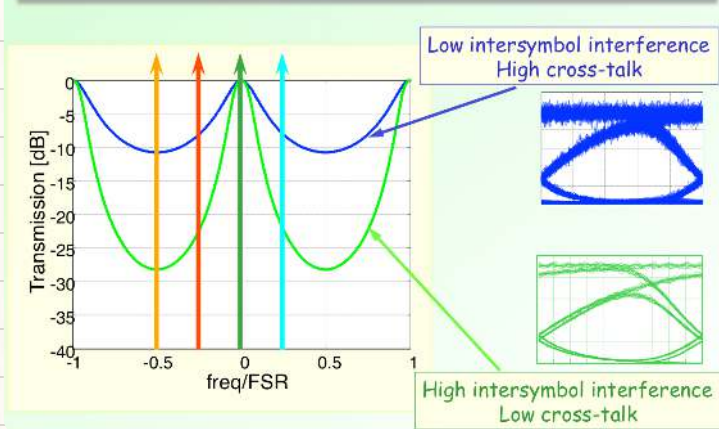

small bandwidth → long time response ISI

large bandwidth → noise, distortion

Single ring resonator transfer function

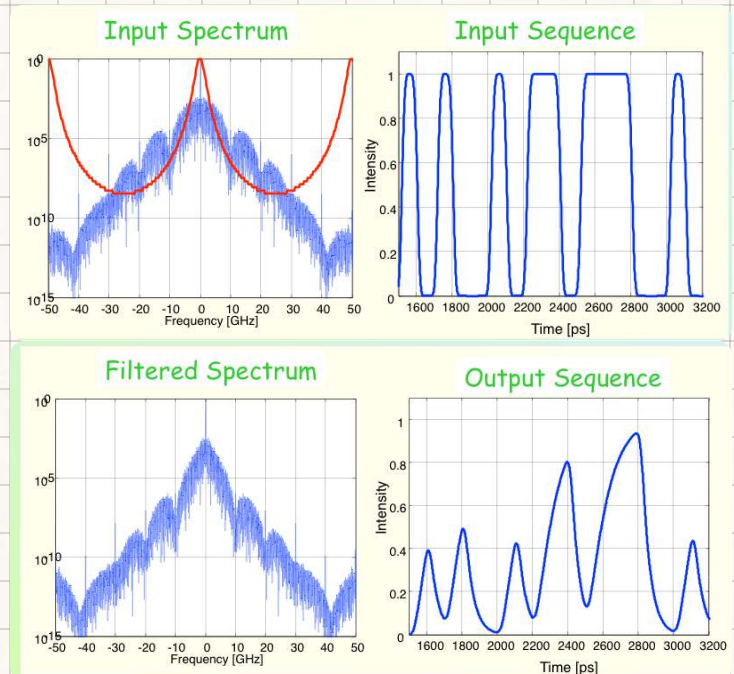
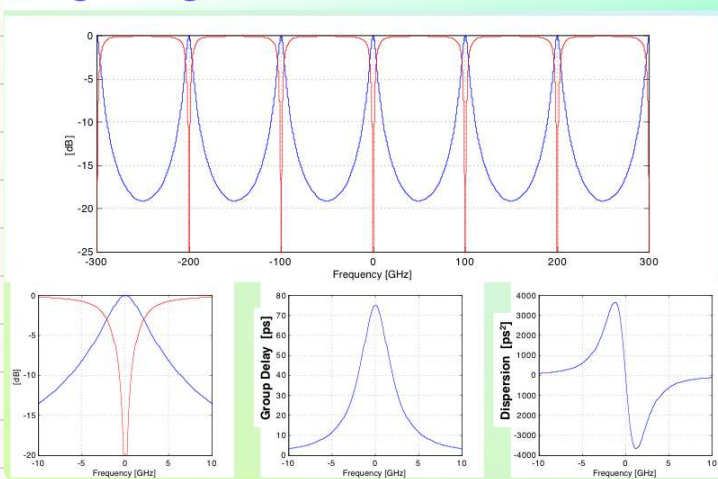

small time response, the fronts don't have

time to rise

dispersion causes delays, enlargements of the pulses

↳ ISI CAUSES DEFORMATION: 3RD ORDER DISPERSION, asymmetric effect

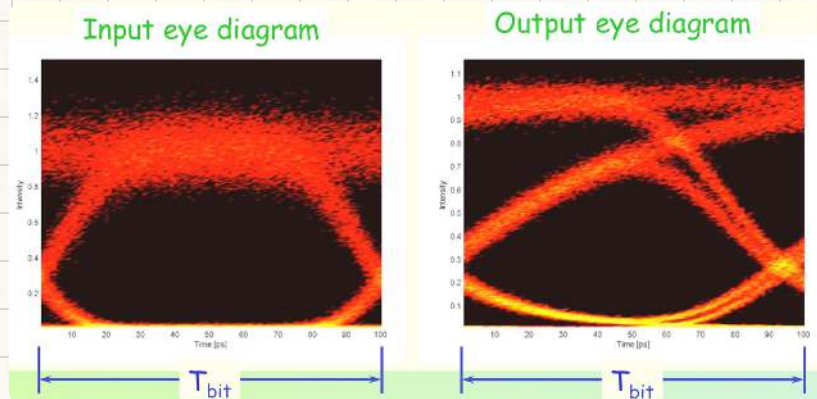
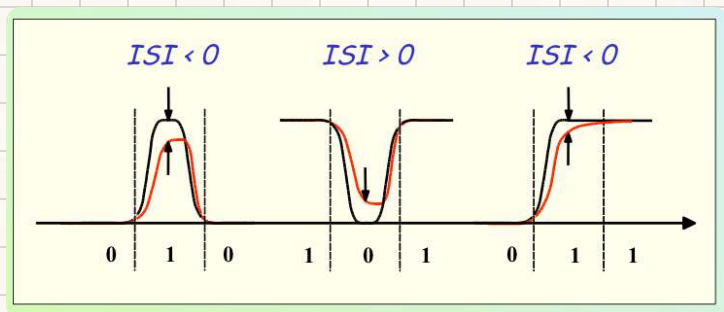

Single Ring Filter Impact (B)

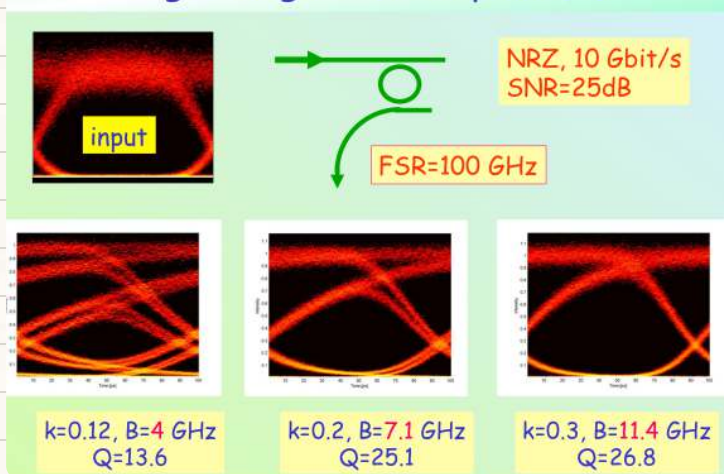

REDUCING BANDWIDTH increases ISI and the eye closes

each line is a transition between filters

↳ ALSO DUE GROUP DELAY AND PHASE RESPONSE

EFFECT OF DE-TUNING

δf

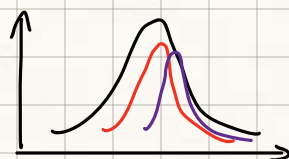
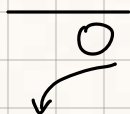

eye diagram closes and the low frequency component is attenuated

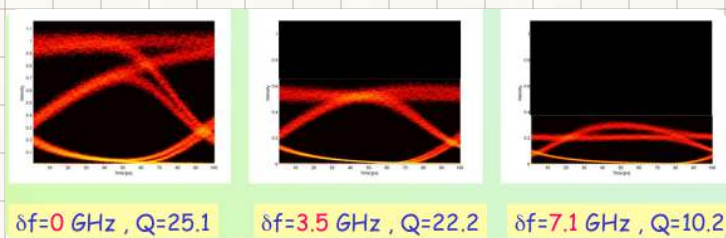

↳ no ISI, smaller eye

we need an ADAPTIVE FILTERING CONTROLLED BY FEEDBACK FROM THE RECEIVER

detuning (tuning) a little bit we can attenuate a bit reducing interference's effect

LOADED MZ:

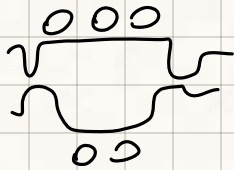

nice flat transfer function

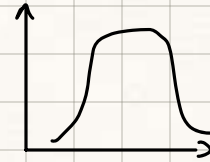

BUT GROUP DELAY RESPONSE HAS PEAKS!

we must stay inside the peaks to avoid large chromatic dispersion

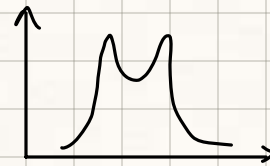

group delay is general multiplied in cascaded rings, distortion can become very big

↳ we can equalize it and MAKE IT FLAT

TUNABLE DELAY LINE:

possibilities: use the resonance of a circuit or ring

↳ PEAK in GROUP DELAY

$$\tau_g = \frac{1+r}{1-r}, \quad r = \sqrt{k}$$

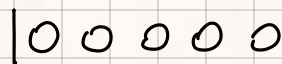

for $\lambda = \lambda_r$:

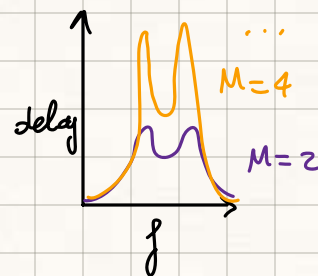

reduce the speed of the light, use

TECHNOLOGIES

CLEANROOM: air is controlled for particles, polifab ISO 6, TMTC ISO 1

inside pressure > outside pressure

FLOOR has the output air filters, air is then recycled

ENVIRONMENTAL PARAMETERS:

$T = 19^{\circ} \sim 21^{\circ} C \quad \pm 1^{\circ} \sim 0,2^{\circ} C \rightarrow$ CHANGES IN T CHANGE THE YIELDS OF THE INSTRUMENTS

humidity 40%

MATERIAL:

Silicon Wafers are mainly used : Si

Abundant, fairly cheap

MANUFACTURING:

two steps \rightarrow FRONT-END : wafer fabrication, probing

BACK-END : Assembly, packaging the die, final test

devices are made of PLANAR LAYERS stacked on top of the others

TRANSFER OF PATTERN \rightarrow ETCHING :

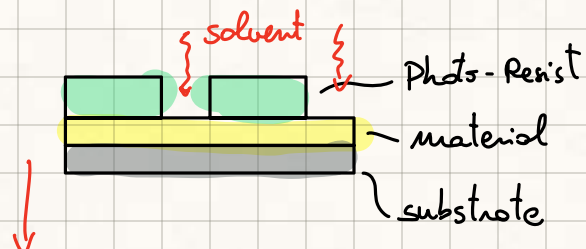

\rightarrow LIFT-OFF :

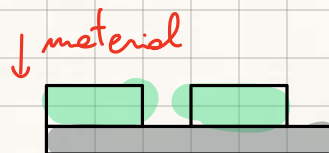

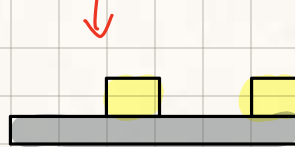

BUILDING BLOCKS:

- LITHOGRAPHY → put some photoresist and write the design using a UV light
- DOPING
- DEPOSITION
- ETCHING → remaining material can be with chemicals or gases

PACKAGING:

cutting the die, setup contacts and connections + enclosure

MICRO FABRICATION

it's possible to enter some multi design runs

↳ defined design rules in order to realise the device → PDK

designer can see the rules and design

↳ foundry technologies are not disclosed

inside the PDK there's a list of available building blocks

(rings, resonators, ...)

MATERIALS

Si + doping material →

Si Ge
SiON
SiOC

} DIELECTRIC, TRANSPARENT IN 1550nm

ACTIVE MATERIAL: ImP 3-5 materials

stoichiometric material \rightarrow the refractive index does not change

SILICON is the starting point \rightarrow AMORPHOUS OR POLYCRYSTALLINE

\hookrightarrow the crystal is built in a furnace from a "seed" crystal
molten silicon attaches to the seed

\hookrightarrow then the cylinder is cut in wafers

WAFERS GET COVERED IN OXIDE SiO_2 LAYER

$\sim 7 \mu\text{m}$ thickness
 $\times 30 \text{ cm}$ diameter

to access silicon we need to etch in void

GROW \rightarrow CRYSTAL, DEPOSIT \rightarrow AMORPHOUS

DEPOSITION TECHNIQUES

CVD: Chemical vapor deposition, reactions at surface produce deposition
 \hookrightarrow uses a GAS "precursor"

PVD: Physical Vapor Deposition \rightarrow produce atoms to go on the surface
proton launched on metal producing ions
and annealing to fix those in the metal

Other: Liquid spinning + solidification

Plasma is used to break bonds in materials \rightarrow create IONS

\hookrightarrow NO PLASMA: low deposition rate, 900°C , Multi wafer system

\hookrightarrow PLASMA-ENHANCED CVD: faster, high deposition rate, 300°C , small batches

Evaporation

A source material, contained in a crucible, is heated in a vacuum chamber

How is heated up? With a Tungsten filament or with an electron beam properly directed.

There will be a flux of vapor that goes from the heated crucible to the substrate, NO PLASMA.

Since the source material is usually not perfectly uniform (usually in small pieces or dust), and the flux is very directive, there is a very bad uniformity in the deposition.

Few pros and cons:

- Almost every material can be evaporated
- Easy procedure
- Very bad **step coverage**
- Difficult compound deposition (due to different evaporation rates)

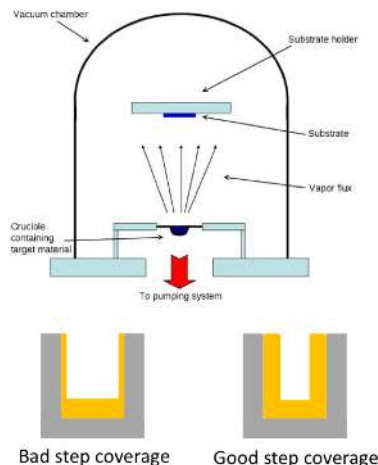

Sputtering

In sputter deposition a plasma (usually Ar^+ based) is used to dislodge atoms from a source target material, these atoms will then deposit on the substrate

Example with chromium

The Cr atoms that migrates to the substrate surface can:

- Stay absorbed: deposited
- Migrate on the surface: step coverage
- Be re-emitted

Secondary electrons generation:
plasma self-sustainability

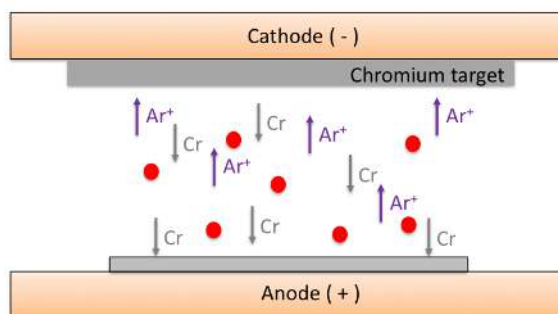

↑ ionic current between the two materials

METAL DC VOLTAGE

DIELECTRIC RF VOLTAGE → RF SPUTTERING $f \approx 15 \text{ MHz}$

MAGNETIC → MAGNETO-SPUTTERING

CO-SPUTTERING → multiple targets

REACTIVE-SPUTTERING → there's an atmosphere that reacts with the particles

ANNEALING:

high temperature oven to settle the wafer's properties after some depositions

↳ it removes impurities that can cause absorption or scattering

Material can shrink by up to 10% → increase of Δn

LITHOGRAPHY :

water or alcohol
ultrasonic bath ←

illuminate where we
WANT/DON'T WANT THE WAVEGUIDE ←

↳ RESIST CAN BE POSITIVE
OR NEGATIVE

Lithography: optical lithography

Process overview

1. Wafer cleaning
2. Resist spin coating **PHOTORESIST**
3. Pre-exposure bake
4. Exposure
5. Development
6. Auxiliary post-exposure bake

- RESIST →
- 1) HIGH PATTERN FIDELITY
 - 2) GOOD REACTIVITY TO INCIDENT POWER
 - 3) RESISTANCE TO SUCCESSIVE STEPS

4. Exposure

Here comes the light.

The concept is simple: we use light to induce a change in the chemical compound of the photoresist in order to make the exposed part more (positive) or less (negative) soluble in the developer with respect to the non-exposed part.

Negative Positive

pattern is transferred by a QUARTZ photo-mask, gets illuminated
or DIRECT WRITING, no need for a mask but longer and less precise

Lithography: optical lithography

1:1 Exposure Systems

- Contact Printing**
 - 1x mask required
 - Risk of damages
- Proximity Printing**
 - 1x mask required
 - Resolution limits (few μm)

4X or 5X Reduction

- Projection Printing**
 - High resolution
 - Resolution limits

Example of projection exposure with a stepper machine

- Light
- Reticle (mask)
- Lens
- Pattern being repeated onto wafer
- Wafer (with photoresist)

WRITING :

→ laser beam

↳ electron beam : can be very thin 0.1 nm

↳ in practice 20 nm MAXIMUM!

small writing area and lots of susceptibility to noise

need to use feedback pre-compensation

Technique	Resolution	Speed	Cost	Flexibility	Dimension limit
UV Lithography	Down to 50 nm (depending on exp. system)	200 WPH	Low	Low (needs mask)	Depending on mask
Direct-writing LED	500 - 1000 nm	< 10 WPH	Low	Very high	Limited by stage
E-Beam Lithography	20 nm	< 10 WPH	High	High	Few mm
Extreme UV	Down to 5 nm	100 WPH	Very very high	High	Limited by stage and source power
Nanoimprinting	10 nm	50 WPH	Low	Low (needs mold)	Depending on mask

↳ pushing down a physical structure to leave a negative mark

ETCHING:

Etching

The resist is only an accessory tool, once patterned you use it to act on a layer that is below the resist

- Can be wet (chemical) or dry (chemical+physical)

Etching parameters:

- Etch rate
Amount of material removed per unit time
- Selectivity
Ratio of the etches of different materials
Mask and materials underneath the film to be patterned must be preserved
- Anisotropy
Vertical etch rate/horizontal etch rate
Sometimes, like for waveguide realization, this parameter plays a key role
- Uniformity

BRAGG GRATING

Periodic perturbation of the refractive index



or change the width of the waveguide (changes index of a section)

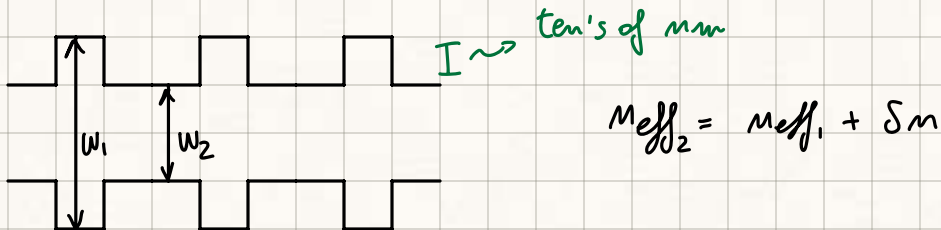

We modify the wave vector of the propagating field

The grating increases the reflectivity compared to a standard perturbation

BRAGG GRATINGS: gratings that couple COUNTERPROPAGATING MODES

↳ TO REALIZE FREQUENCY REFLECTIVE MIRROR

PHOTOREFRACTIVE EFFECT:

Use this effect to change the refractive index of portions of the waveguide using light radiations (UV light)

↳ vary the absorption spectrum leads to a change in n_{eff}

light breaks bonds changing the density of electronic population

The material also gets denser and the index changes.

WRITING TECHNIQUES:

use an interferometric system (UV LAMP)

Interferometric writing of Bragg grating

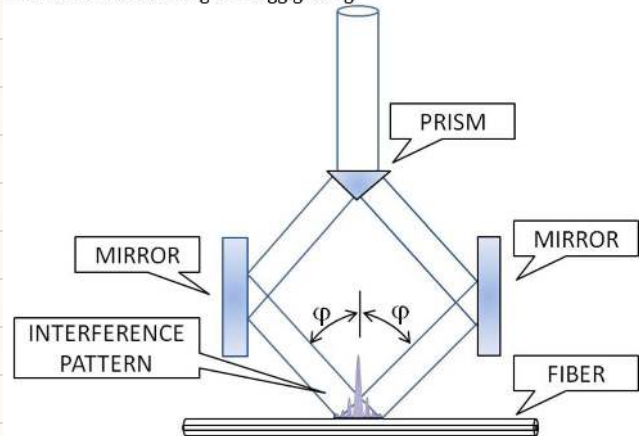

Prism → Power splitting

recombine the light and generate an interference

the period depends on the interference ANGLE

$$\Lambda = \frac{\lambda_{UV}}{2 M_{UV} \cdot \sin(\theta/2)}$$

Phase Mask writing of Bragg grating

on a PHASE MASK

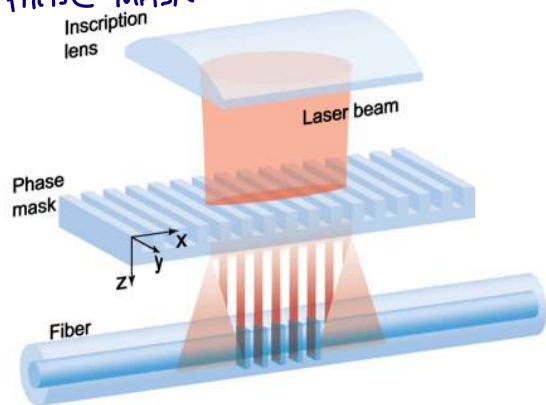

Put the fiber close to the periodic pattern of the mask

ADVANTAGE: stability

DISADVANTAGE: Flexibility (changing pattern)

$$\Lambda = \frac{\Lambda_{PM}}{2}$$

INFORMAL DESCRIPTION:

We modify the wave vector of the propagating field

- The grating increases the reflectivity compared to a standard perturbation

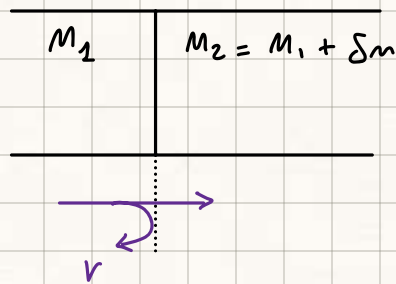

consider a 'small' perturbation
(no excitation of higher order modes or radiation)

$$\delta m \ll m_1$$

$$r = \frac{m_1 - m_2}{m_1 + m_2} \rightarrow \delta m, \text{ small reflectivity}$$

if we want to increase reflectivity we cannot change Δn by much:

ADD ANOTHER DISCONTINUITY

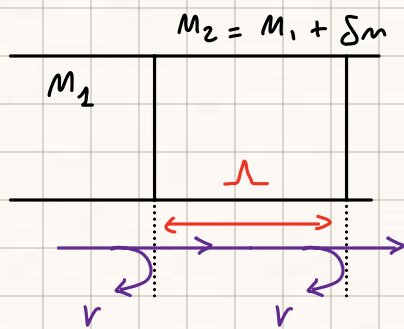

1st reflectivity + 2nd reflectivity + Phase shift of prop. over L must be $2\pi \cdot N$

$$\frac{2\pi}{\lambda} \cdot n_{\text{eff}} \cdot 2L = 2\pi \cdot N$$

BRAGG WAVELENGTH: $\lambda_B = 2n_{\text{eff}} \cdot L$ for which **REFLECTIVITY IS MAXIMUM**

reflection is doubled: $r \rightarrow r^2$

now we consider a PERIODIC PERTURBATION:

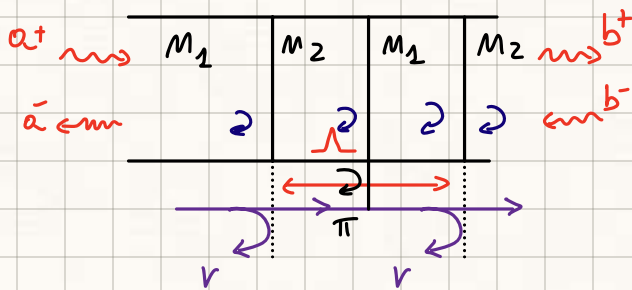

$$\frac{2\pi}{\lambda} \cdot n \cdot 2 \cdot \frac{L}{2} + \pi = 2\pi N$$

TOTAL REFLECTIVITY: $r \rightarrow r^{2M}$ (M period of the grating)

(not totally true because we lose power throughout the guide)

• Derivative of Bragg's condition:

$$\frac{\partial \lambda}{\lambda_B} = \frac{\partial n}{n} = \frac{\partial L}{L}$$

ex: we want $\lambda_B = 1550$ nm, working in Silica $n = 1,45$

$$L = \frac{\lambda_B}{2n} = \frac{1550 \text{ nm}}{2 \cdot 1,45} \approx 531 \text{ nm}$$

for 'match' gratings we have tens of nm of width change, $\Delta n \approx 10^{-4} \div 10^{-3}$

we need even thousands of gratings \rightarrow would need mm or thousand of microns

\hookrightarrow demanding high accuracy (nm) over a long distance

$$\Delta n = 10^{-4} \div 10^{-3}$$

$$L = 100_s \mu\text{m} \div \text{cm}$$

FORMAL DESCRIPTION (COUPLED MODE THEORY)

Dishomogeneity in the index profile geometry introduces coupling between the modes

\hookrightarrow transfer of power and losses in case of radiative modes

For weak perturbation we can EXPRESS THE PERTURBED FIELD AS A LINEAR COMBINATION OF THE MODES OF THE NON-PERTURBED STRUCTURE

total field:

$$\Psi(x, y, z) \approx A(z) \varphi_0(x, y) e^{-j\beta_0 z} + B(z) \varphi_0(x, y) e^{+j\beta_0 z}$$

FORWARD MODE + BACKWARDS MODE

$A(z), B(z)$ are amplitudes depending on $z \rightarrow$ because the two forward and backward modes ARE NOT OF THE GUIDING STRUCTURE

different from couplers \rightarrow presence of index profile dependence on z

$$n_p(x, y, z) = n(x, y) + \Delta n(x, y, z)$$

we put this expression in the wave equation

$$\begin{cases} \frac{dA}{dz} = -j c_{11} A(z) - j c_{12} B(z) e^{-j(\beta_1 - \beta_2)z} \\ \frac{dB}{dz} = -j c_{22} B(z) - j c_{21} A(z) e^{-j(\beta_1 - \beta_2)z} \end{cases}$$

$$c_{ij} = \frac{k_0^2}{\beta_i} \cdot \underline{g(z)} \cdot \iint \varphi_i \varphi_j \delta_m(x, y)$$

$$\delta_m(x, y, z) = \delta_m(x, y) \cdot g(z)$$

$g(z)$ introduces PERIODICITY IN THE PERTURBATION
↳ COUPLING COEFFICIENTS BECOME PERIODICAL

the expansion of $g(z)$:

$$g(z) = \sum_m g_m \cdot e^{jm \frac{2\pi}{\Lambda} \cdot z}$$

when $g(z)$ is sinusoidal (fiber optics) = $g_1 \cdot e^{-j \frac{2\pi}{\Lambda} \cdot z}$

for A, B we obtain:

$$A(z) = A(0) - j c_{11} \sum_m g_m \int_0^z e^{j \frac{2\pi}{\Lambda} \cdot z} A(\eta) d\eta - j c_{12} \sum_m g_m \int_0^z e^{j \left(m \frac{2\pi}{\Lambda} - (\beta_1 - \beta_2) \right) \eta} B(\eta) d\eta$$

VECTOR OF AMPLITUDE 1

every period of the grating it rotates by 2π

contributes of the integrals are null except when the exponent is close to 0

↳ first integral is non-null for $m=0$ (continuous component of dm)

• second integral is non null for PHASE MATCHING (SINCRONISMO)

$$\underbrace{\beta_1 - \beta_2}_{2\beta_0} = \frac{2\pi}{\Lambda} \cdot m$$

↳

BRAGG'S CONDITION

$$\lambda_B = \frac{2 \cdot m \cdot \Lambda}{m}$$

BRAGG'S CONDITION

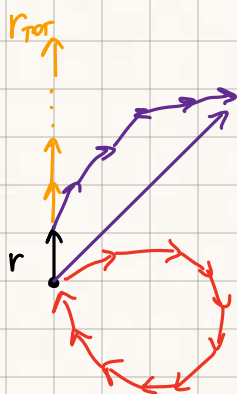

→ integrand is not negligible

we could arrive at this condition

From a physical point of view the grating has a WAVE VECTOR (even if it's not a wave): introduces a component $e^{j(\frac{2\pi}{\Lambda} \cdot m - (\beta_z - \beta_1)) \xi}$ that modifies the wave's wave vector

W- β DIAGRAM AND EXCITATION

we consider the two excited modes for MONOMODALITY REGIME:

- fundamental mode propagating along $+z \rightarrow \beta_1 = \beta_0$
- fundamental mode propagating along $-z \rightarrow \beta_2 = -\beta_0$

$$\beta_1 - \beta_2 = 2\beta_0$$

we ignore the radiative modes

PHASE MATCHING: $\beta = \frac{\pi}{\Lambda} \cdot m$, $\bar{\lambda} = \frac{2 \cdot m_{eff} \cdot \Lambda}{m}$

we can use the ω/β diagram of a waveguide:

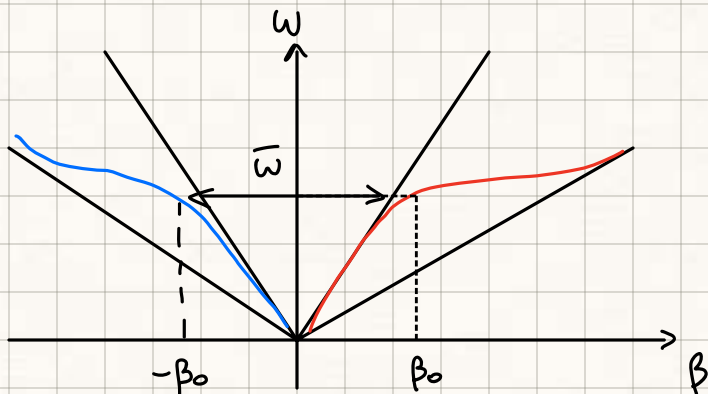

• forward mode

• backward mode

- Coupling must be between fields at the same frequency, we can only move horizontally
LINEARITY OF THE SYSTEM

- the vectors connecting β_1, β_2 does not have a sign and does not depend on the refractive index

FOR A MULTIMODE FIBER: is it possible to couple two

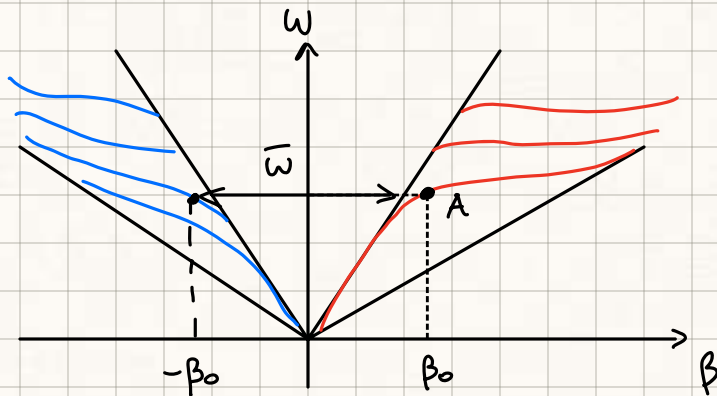

$$\Omega = \lambda \cdot (m_{eff,0} + m_{eff,1})$$

choosing an input mode (assume we want monomodality and select point A we can choose to EXCITE ONE OF THE BACKPROPAGATING MODES \rightarrow CHOOSE Ω ACCORDINGLY

We need the DISCONTINUITY TO ALLOW THE EXCITATION OF THE MODE

\hookrightarrow if $C_{ij} = 0$ fields A and B won't share power even if the synchronism condition is respected

* una perturbazione di campo DISPARI non viene eccitata se il profilo della perturbazione $\Delta m(x,y)$ è una funzione pari di (x,y)

$$C_{ij} = \frac{k_0^2}{\beta_i} \cdot g(z) \cdot \iint \cancel{\varphi_i \varphi_j} \Delta m(x,y)$$

\hookrightarrow this goes to 0

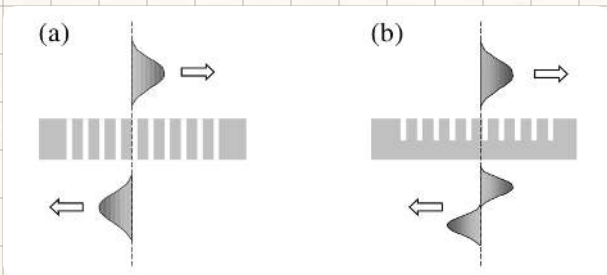

2) EVEN discontinuity excites the even backpropagating mode

UNIFORM BRAGG GRATINGS

$\mathcal{L}, \delta n = \text{constant}$

perturbation is periodical, we can solve coupled equations:

$$\begin{cases} \frac{dA}{dz} = -j c_{11} A(z) - j c_{12} B(z) \cdot e^{j\Delta\beta z} \\ \frac{dB}{dz} = -j c_{22} B(z) - j c_{21} A(z) e^{-j\Delta\beta z} \end{cases}$$

where $c_{12} = c_{21}$, $\Delta\beta = 2\beta_0$

we rearrange the system in normalized form:

$$a(z) = A(z) e^{-j(\beta_1 - \frac{\pi}{\mathcal{L}})z}$$

$$b(z) = B(z) \cdot e^{-j(\beta_2 + \frac{\pi}{\mathcal{L}})z}$$

$$\frac{da}{dz} = -j\sigma a(z) - j\kappa b(z)$$

$$\kappa = \frac{\pi \delta n}{\lambda}$$

$$\frac{db}{dz} = j\sigma b(z) + j\kappa a(z)$$

$$\sigma = \frac{2\pi \cdot n_{\text{eff}}}{\lambda} - \frac{\pi}{\mathcal{L}}$$

for a SINUSOIDAL
PERTURBATION

The transmission matrix has form:

$$T_g = \begin{bmatrix} \cosh(\delta L) - jR \sinh(\delta L) & -jS \sinh(\delta L) \\ jS \sinh(\delta L) & \cosh(\delta L) + jR \sinh(\delta L) \end{bmatrix}$$

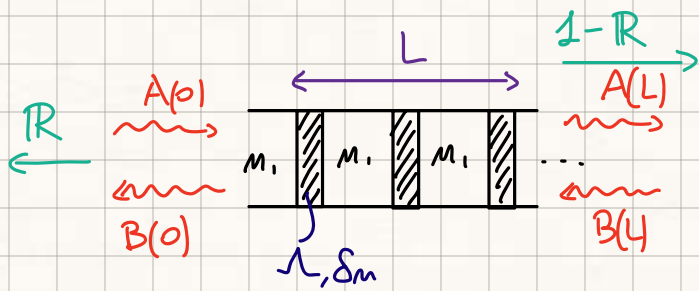

$$\begin{bmatrix} A(L) \\ B(L) \end{bmatrix} = T_G \begin{bmatrix} A(0) \\ B(0) \end{bmatrix}$$

$$R = \sigma / \delta \rightarrow S^2 - R^2 = 1$$

$$\delta = \sqrt{k^2 - \sigma^2}$$

$$S = k / \delta$$

$$\det(T_G) = 1$$

we have an hyperbolic function: $k = \sqrt{G_2 C_{21}}$

↳ k it's either imaginary or we consider it real and switch to an hyperbolic function

$$\text{REFLECTIVITY: } R = \left| \frac{T_{G 21}}{T_{G 11}} \right|^2 = \left| \frac{I_2}{I_1} \right|^2 = \frac{\sinh^2 \delta L}{\cosh^2(\delta L) - (R/S)^2}$$

RATIO BETWEEN INTENSITY OF REFLECTED WAVE AND INCIDENT WAVE

TRANSFER FUNCTION ANALYSIS:

• Bragg's condition: $\lambda_B = 2 \Lambda \cdot n_{\text{eff}} \rightarrow$ perturbation with average value = 0

$$\sigma = \frac{2\pi \cdot n_{\text{eff}}}{\lambda} - \frac{\pi}{\Lambda} = 0 \rightarrow R_M = \tanh^2(kL)$$

we have MAX REFLECTIVITY:

reflectivity depends on the length of the grating L and k intensity of the reflectivity of every component

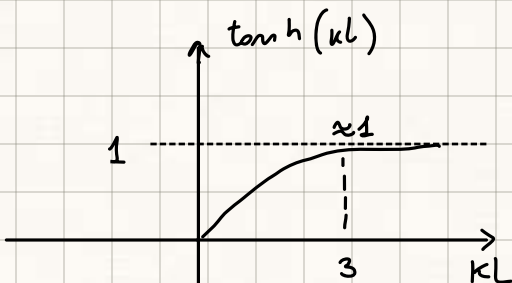

$$kL = 3 \rightarrow \frac{\delta m \cdot \pi \cdot L}{1,55} \rightarrow L \approx \frac{3 \cdot 3}{2 \cdot 10^{-4} \cdot \pi} \sim 1 \mu\text{m}$$

• FAR AWAY from Bragg's condition:

$\delta = \sqrt{\kappa - \sigma}$ becomes imaginary

S is very small

$$T_G = \begin{bmatrix} e^{-j\sigma L} & 0 \\ 0 & e^{j\sigma L} \end{bmatrix} = \begin{bmatrix} e^{-j\beta L} & 0 \\ 0 & e^{j\beta L} \end{bmatrix}$$

behaves like UNCOUPLED LINES

the grating becomes transparent

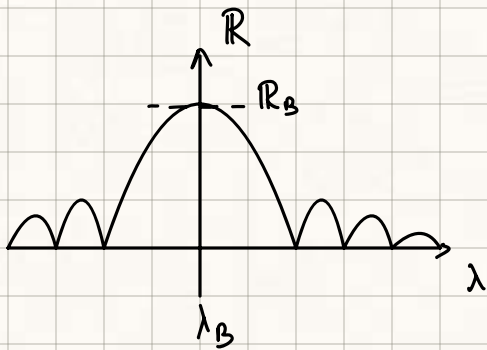

Bandwidth depends on κL

REFLECTION SPECTRUM FOR UNIFORM GRATINGS

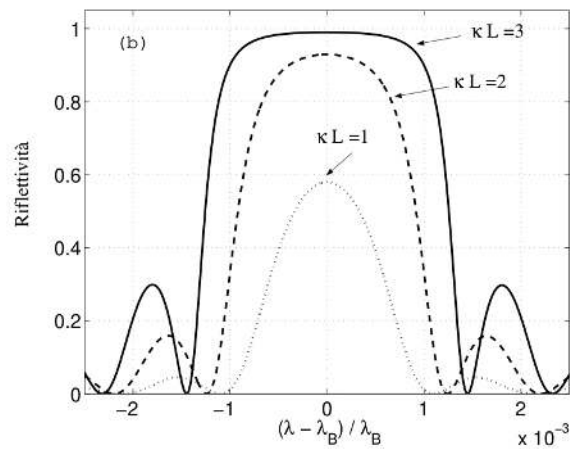
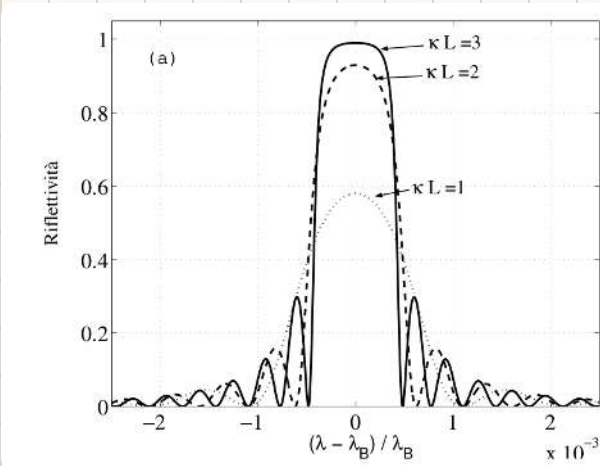

varying: L length

R_{max} increases with L
1 for $\kappa L > 3$

κ modulation amplitude

we vary ν δ_{eff}

R remains high as long σ is small \rightarrow close to λ_B

increasing κ we ALSO INCREASE THE BANDWIDTH

• BANDWIDTH:

→ FOR WEAK GRATING BANDWIDTH DEPENDS ON LENGTH

$$\Delta\lambda \approx \frac{\lambda_B^2}{n_{\text{eff}} \cdot L}$$

↳ FOR STRONG GRATING: BANDWIDTH DOES NOT DEPEND ON LENGTH

light is completely reflected before the end

↳ bandwidth only depends on δn_{eff}

$$\Delta\lambda = \lambda_B^2 \cdot \frac{n \cdot \delta n_{\text{eff}}}{n_{\text{eff}}}$$

TO GET HIGH REFLECTIVITY OVER A LARGE BANDWIDTH WE NEED HIGH INDEX MODULATION

Central lobe of reflection is followed by some tails

↳ caused by the finite length of the grating, the interfaces cause small reflections

behaves as a Fabry perot, the reflection goes null for the resonating frequencies

the spacing is the FSR of the Fabry-Perot of length L

GROUP DELAY:

$$\tau_g = \frac{d\varphi}{d\omega} = \frac{\lambda^2}{2\pi c} \cdot \frac{d\varphi}{d\lambda}$$

Group delay has the meaning of time necessary for the beam for passing through the grating

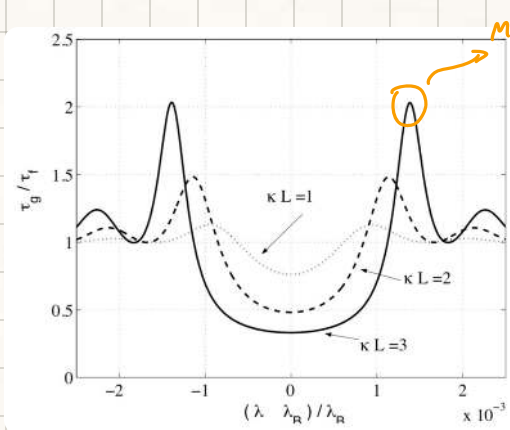

if the reflectivity is very strong, the time the light that needs to be reflected takes to reappear at the input is pretty small

τ_g decreases for lower $\kappa \rightarrow$ for a WEAKER REFLECTIVITY \leftrightarrow LARGER GROUP DELAY

group delay is flat in the central part \rightarrow a pulse can be reflected with very low chromatic dispersion

(not like a scattering media)

there should be a point where the light is reflected

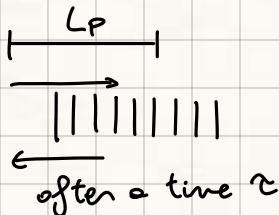

we can define a PENETRATION LENGTH, position that is L_p distant from the input, it's an index of the field penetration in the grating

$$L_p = \frac{c \cdot \tau_g}{n_{\text{eff}}} = \frac{r_m \cdot \lambda_B}{2\pi \cdot r \cdot \delta n_{\text{eff}}} \quad r_m = \sqrt{R M}$$

moving from the Bragg's condition the group delay increases

↳ MAX τ_g happens for resonance in the cavity

SURFACE GRATING ON A WAVEGUIDE

corrugate the surface of a waveguide

Gaussian Pulse, fundamental mode

↳ very broad spectrum → SOME FREQUENCIES PASS AND SOME NOT (radiated away)
(short pulses, femtoseconds)

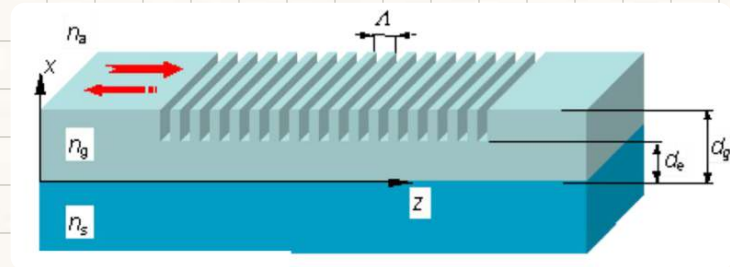

- As pulses propagate we see the effect of chromatic dispersion

- At some point it arrives at the surface grating

↳ IT'S ASYMMETRIC, IT WILL EXCITE HIGHER ORDER MODES and then reflects

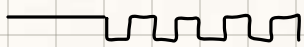

the effect of radiated and higher order modes can lead to 'unexpected' results

APODIZED GRATING :

Used to remove lateral reflectivity spikes \rightarrow adapt the grating to the waveguide
remove the impedance jump at the borders

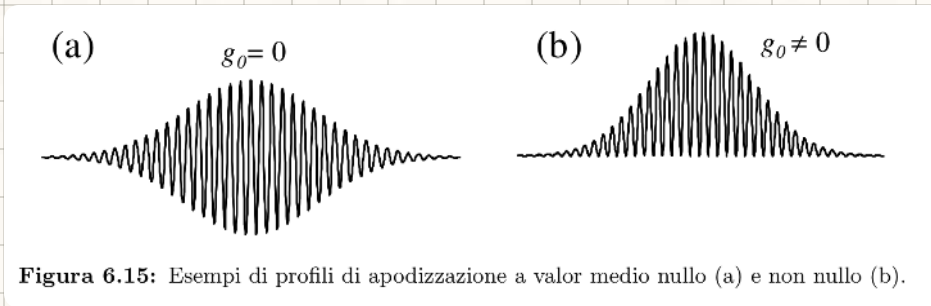

APODIZED: visibility function has dependency on z

the ω - β diagram gives information about the matching of phase and wave-vector, not about the strenght of the coupling

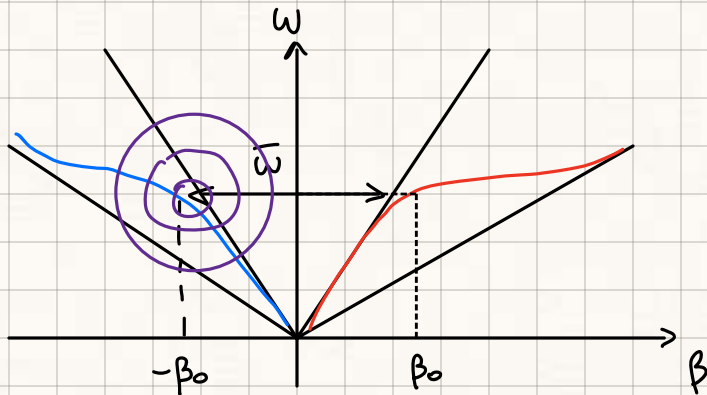

THE STRENGTH CAN BE SEEN AS A CIRCLE AROUND THE VECTOR

\hookrightarrow COUPLING AREA INCREASES WITH THE STRENGTH OF THE GRATING

Rule of thumb: Apodized grating is ~ 3 times longer than the uniform

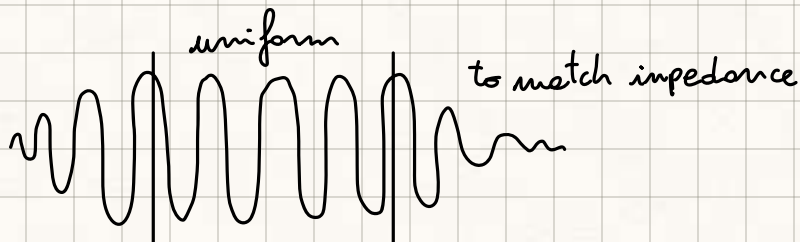

Group delay is longer for apodized since penetration length is longer

APODIZED INCREASES "NORMAL" GROUP DELAY BUT STRONGLY REDUCES REFLECTIONS AT INTERFACES AND SMOOTHS THE REFLECTIVITY AND DELAY RESPONSE REMOVING PEAKS AND SIDELOBES



Figura 6.16: Spettro di riflettività (a) e ritardo di gruppo normalizzato (b) per un reticolo uniforme (linea tratteggiata) e un reticolo apodizzato con profilo gaussiano (linea continua).

group delay is increased close to λ_0 because for weak coupling at the start of the grating we have higher penetration length

CHIRPED GRATING:

the period Λ is not constant

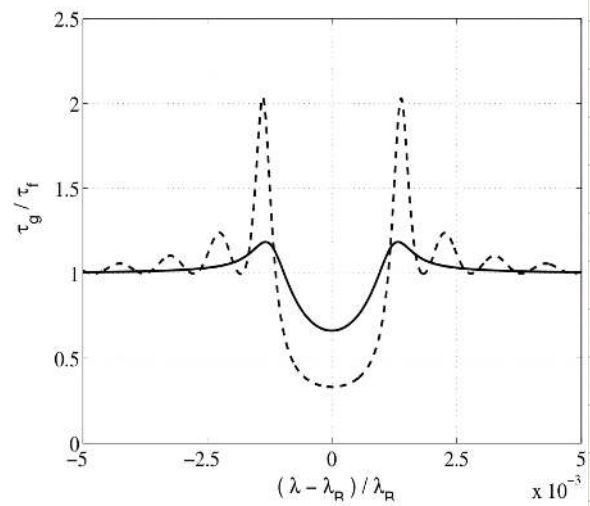
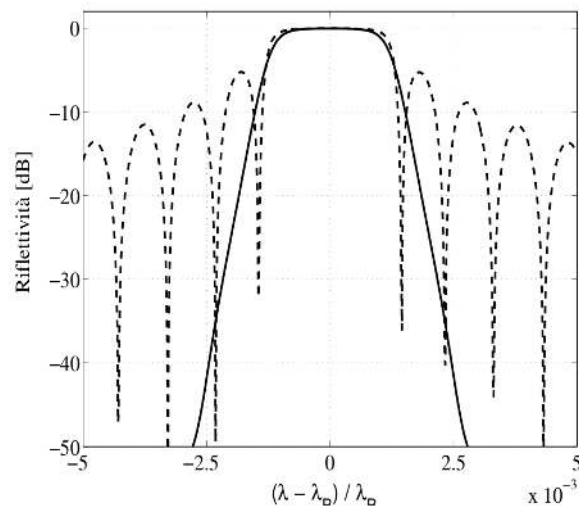
$$\Lambda(z) = \Lambda_0 + C \cdot z$$

↳ CHIRP

Bragg wavelength depends on the position

$$\lambda_B = 2m\Lambda_s = 2m_{eff}\Lambda(z)$$

we get a LARGE REFLECTIVITY BANDWIDTH

(normally depends on $\Delta m \rightarrow$ we coscode a number of gratings)

$$\Delta\lambda = 2m_{eff}(\Lambda_c - \Lambda_s) = 2m_{eff} \cdot C \cdot L$$

↓
MAX-MIN PERIOD

fixed Δm it's necessary for the grating to include a sufficient number of periods to satisfy the synchronous conditions $\rightarrow k \cdot \Delta L$ must be high enough

GROUP DELAY: different λ s are reflected in different points of the grating

↳ τ_g INCREMENTS LINEARLY! (decreases for neg. chirping)

$$\tau_g = \frac{\lambda - \lambda_s}{c \cdot C} \quad \text{depends on wavelength}$$

\uparrow \uparrow
 speed of light chirp

CHROMATIC DISPERSION: CAN BE DESIGNED! (only depends on chirp parameter C)

$$\frac{\partial \tau_g}{\partial \lambda} = \frac{1}{c \cdot C} = D_g$$

we can do a "re-timing" of the delay and do DISPERSION COMPENSATION



Figura 6.20: Spettro di riflettività (a) e ritardo di gruppo (b) per un reticolo chirpato non apodizzato.

Oscillations are caused by the cavity effect since the grating is NOT APODIZED

↳ applying apodization we REDUCE THE BANDWIDTH BUT ELIMINATE OSCILLATIONS IN THE τ_g

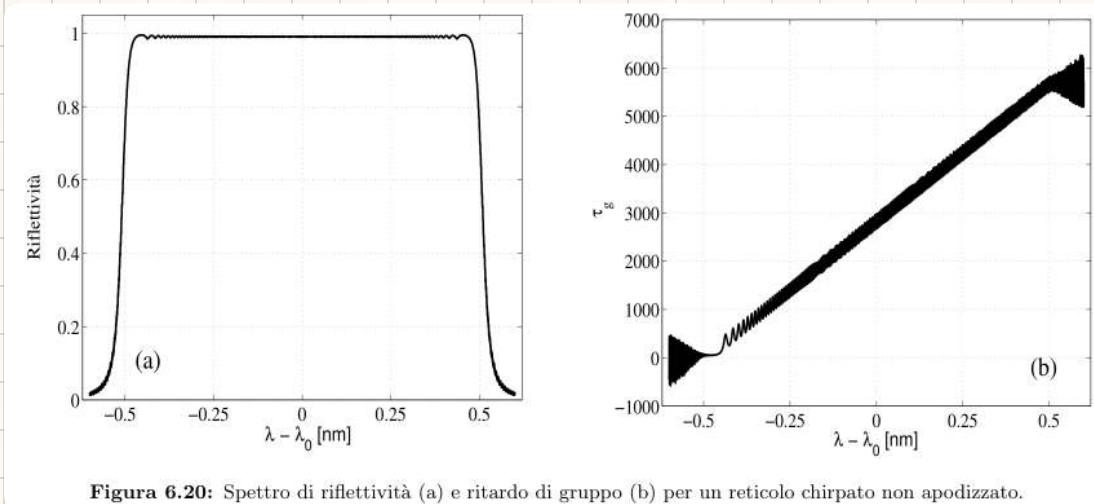

Figura 6.22: Spettro di riflettività (a) e ritardo di gruppo (b) per un reticolo chirpato apodizzato.

Oscillations are most from the input → apodization at output is not always necessary

Assume extracting a certain λ from the system

$$\textcircled{1} \quad \lambda_B = 2\pi L$$

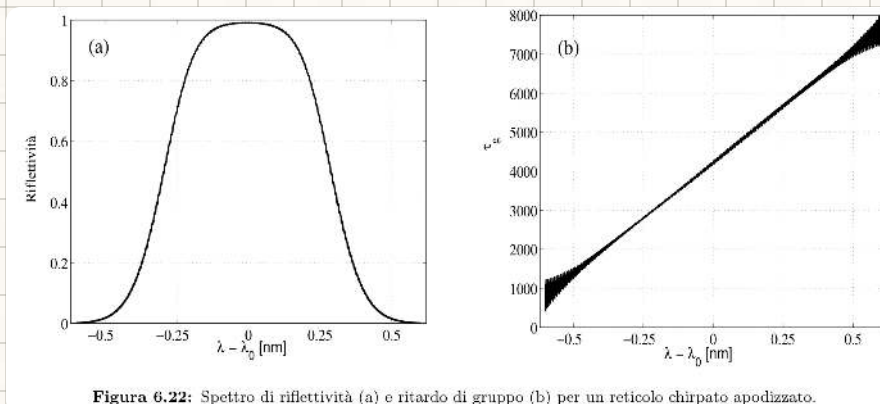
$$\textcircled{2} \quad \frac{B}{\lambda_B} = \frac{\delta m}{n}$$

$$\textcircled{3} \quad R_B = \tanh^2 \left(\frac{\pi \delta m \cdot L}{\lambda_B} \right)$$

FOR UNIFORM GRATING

↳ FOR AN APODIZED WE NEED $3 \times L$

reflectivity in function of wavelength:

$$R(\lambda) = \frac{\sinh^2(\delta L)}{\cosh^2(\delta L) - \left(\frac{\delta}{K}\right)^2}$$

transmission at Bragg's wavelength:

$$T = 1 - R_B = \operatorname{sech}^2 \left(\frac{\pi \delta m \cdot L}{\lambda_B} \right)$$

TO KNOW: • how Bragg gratings work with ω, β diagram

- relation of optical characteristics with spectral behaviour



APPLICATIONS OF BRAGG GRATINGS:

selection of a wavelength

1. USING A BALANCED MZ

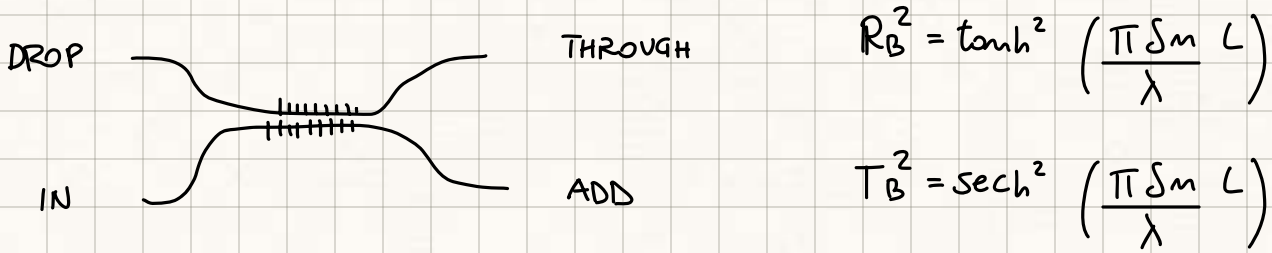

At Bragg wavelength the two fields are reflected and come back

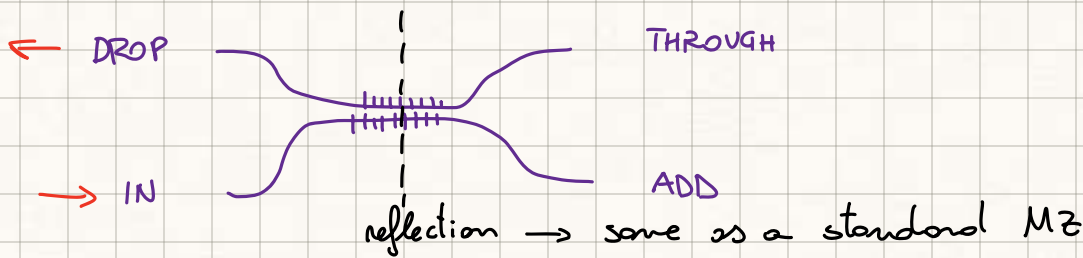

in a circuit like this, if the gratings are not in the same position one of the arms will accumulate a phase shift

↳ we need perfect matching

250 nm → phase shift and we do not exit completely from the upper port difference

↳ Michelson interferometer

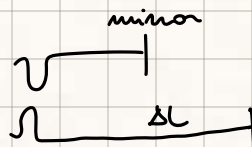

transfer function: $\cos^2\left(\frac{\Delta\phi}{2}\right) \rightarrow$ to be 0 we need $\Delta\phi = k\pi$

other part: $\sin^2\left(\frac{\Delta\phi}{2}\right) \approx \left(\frac{\Delta\phi}{2}\right)^2 < 0.01$ we need very low $\Delta\phi$ (2dB)

CIRCULATOR: → USED FOR A BRAGG GRATING-BASED ADD-DROP MULTIPLEXER

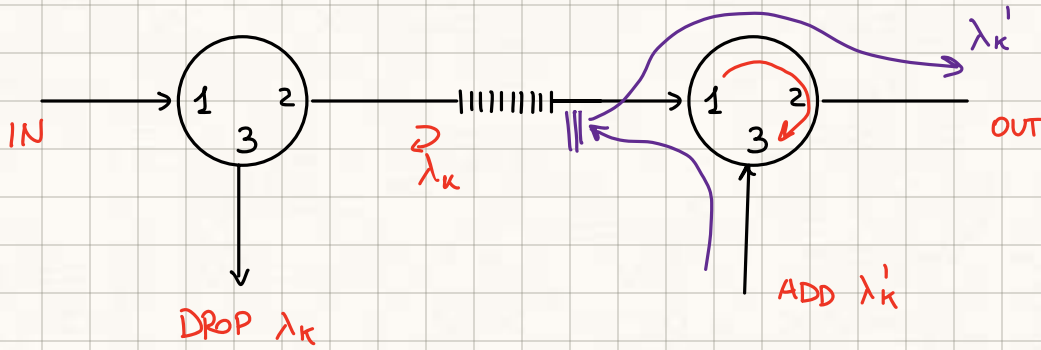
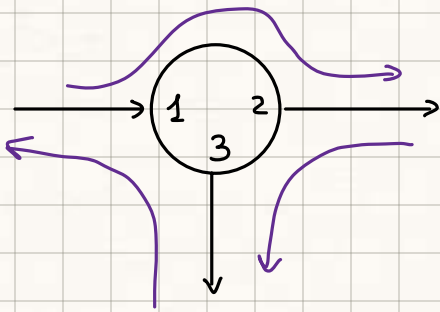

DISADVANTAGE: cannot be realized in integrated optics

circulator is good for separating the incoming signal without expensive attenuation

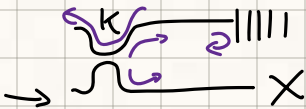

here we have two splitters and two ports with K
↳ -6dB

EXAMPLE: gratsim Matlab command

$$\lambda_B = 1550 \text{ nm}$$

$$\bar{n} = 1,55$$

$$\delta n = 5 \cdot 10^{-4}$$

$$L = 2000 \mu\text{m}$$

$$\text{period } \Lambda = \frac{\lambda_B}{2\pi}$$

$$\text{n}^\circ \text{ of periods } N = \frac{L}{\Lambda}$$

n^o of slices (1 for uniform) or change if we want to see field inside the grating

$$R = \tanh^2 \left(\frac{\pi \delta n L}{\lambda} \right) = 0,933$$

$$B = \delta n \cdot \frac{\lambda_B}{\bar{n}} = 62,5 \text{ GHz}$$

$$\tau_g = \frac{L}{c/\bar{n}} = 10,3 \text{ ps}$$

$$\text{FSR} = \frac{c}{\bar{n} 2L} \rightarrow \text{periodicity of lateral lobes}$$

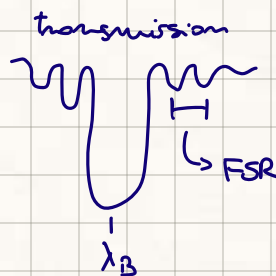
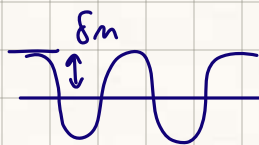

GRATING COUPLERS

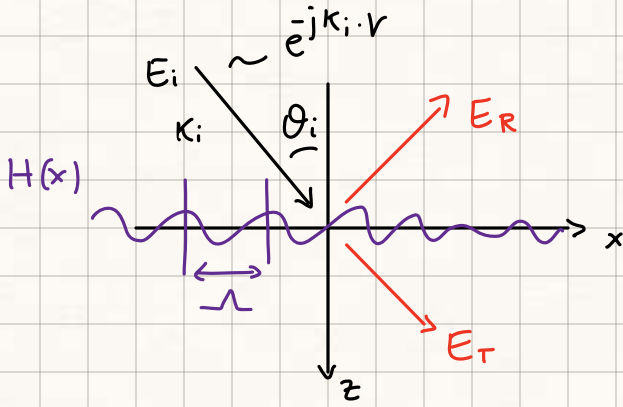

we have a transmitted and reflected field

incident field is multiplied by the wave vector in the two directions

$$\bar{E}_i \cdot e^{-jk_{ix} \cdot \hat{x}} \cdot e^{-jk_{iz} \cdot \hat{z}} + \bar{E}_R(x, z) = \bar{E}_T(x, z)$$

↳ $z = h(x)$ PERIODIC FUNCTION
 \sim PERIODICITY

we express it as Fourier expansion of spatial harmonics

↳ we arrive with a PLANE WAVE,

REFLECTED AND TRANSMITTED FIELDS ARE PROPORTIONAL TO:

$$\begin{aligned} \bar{E}_R, \bar{E}_T &\propto e^{-jk_{ix} \cdot \hat{x}} \cdot g(x, z) \rightarrow h(x) \\ &\propto e^{-jk_{ix} \cdot \hat{x}} \cdot \sum_m R_m \cdot e^{-j \frac{2\pi m}{\Lambda} \cdot x} \cdot e^{-jk_z^{(m)} \cdot z} \end{aligned}$$

↓
harmonics

↳ dependance on z

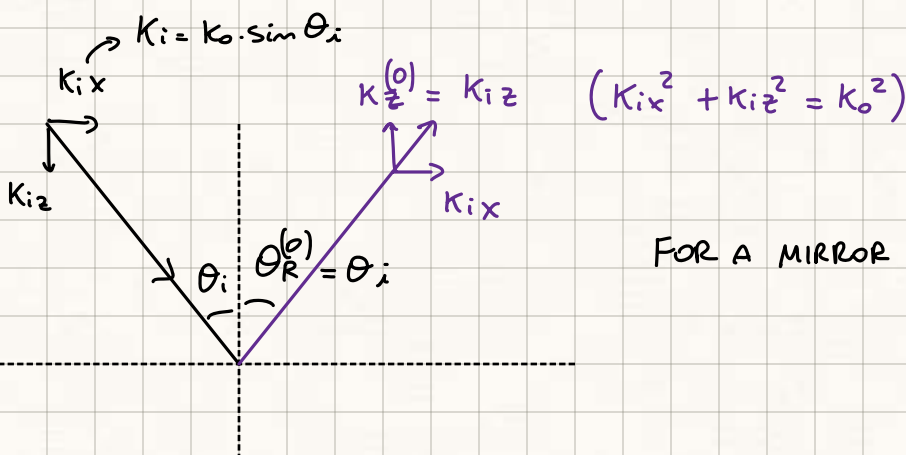

FOR A MIRROR (FLAT SURFACE)

$$\left(k_{ix} + \frac{2\pi m}{\Lambda}\right)^2 + \left(k_z^{(m)}\right)^2 = k_0^2$$

CORRUGATED SURFACE (ALSO OTHER HARMONICS)

$$\hookrightarrow \sin \theta_R^{(m)} = \sin \theta_i + \frac{m \cdot \lambda}{\Lambda}$$

SNELL'S LAW FOR CORRUGATED SURFACE

for a corrugated surface we have many reflections

the intensity of the reflection is given by the coefficient

$$R_m \text{ of } \sum_n R_n e^{-j \frac{2\pi n m}{\Lambda}}$$

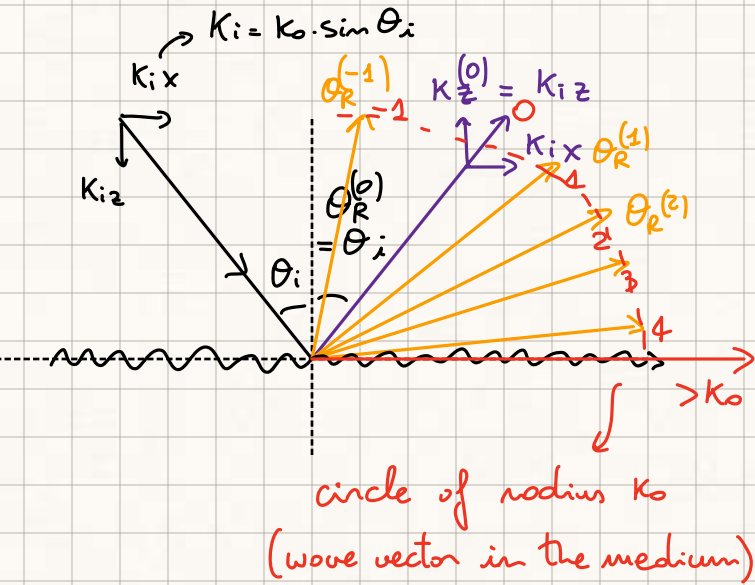

for higher order modes this term for z should be NEGATIVE \rightarrow k_{iz} IMAGINARY!

\hookrightarrow we get an evanescent field, no propagation along z

$$\left(k_{ix} + \frac{2\pi m}{\Lambda}\right)^2 + \underbrace{\left(k_z^{(m)}\right)^2}_{< 0} = k_0^2$$

on x we have a propagation vector longer than k_0

if $k_w = \frac{2\pi}{\lambda} \cdot n_{eff} = \beta$ in the material we can couple the light to the waveguide

$$\xrightarrow{\beta}$$

$$k_w = \frac{2\pi}{\lambda} \cdot n_{eff}$$

EXPERIMENT → MEASURE Λ

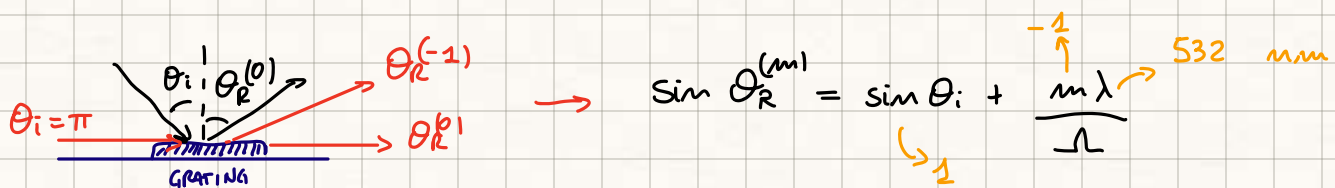

$$\Lambda = \frac{m \lambda}{(\sin \theta_r^m - \sin \theta_i)}$$

we can use this technology to shine light outside of the fiber → antenna
 or for waveguide to fiber coupling

typical bandwidth 50-60 nm

ISOLATORS AND CIRCULATORS

MAGNETO-OPTIC EFFECT

FARADAY EFFECT

we can variate properties of the material using a magnetic field onto it

A lightbeam propagating through a material sees its polarization rotated

IDEA: apply a magnetic field to the guide and use polarization filters to select certain polarizations and block light coming from the opposite direction

nonreciprocal behavior \rightarrow permittivity is an asymmetric tensor

transmission is asymmetrical but reciprocal



This effect is caused by the dielectric tensor \rightarrow NOT SYMMETRICAL

$$\underline{\underline{\epsilon}} = \begin{bmatrix} \epsilon_{xx} & \epsilon_{xy} & 0 \\ \epsilon_{yx} & \epsilon_{yy} & 0 \\ 0 & 0 & \epsilon_{zz} \end{bmatrix}$$

to study wave's propagation we get

$$\begin{bmatrix} -\beta^2 + \omega^2 \mu_0 \epsilon_0 \epsilon_{\perp} & j\omega^2 \mu_0 \epsilon_0 \delta\epsilon \\ -j\omega^2 \mu_0 \epsilon_0 \delta\epsilon & -\beta^2 + \omega^2 \mu_0 \epsilon_0 \epsilon_{\perp} \end{bmatrix} \begin{bmatrix} E_x \\ E_y \end{bmatrix} = 0$$

ADMITS SOLUTIONS ONLY IF $\det(\cdot) = 0$

\hookrightarrow solutions are the waves which can be propagated in the medium

$\delta\epsilon$ ELEMENTS OUTSIDE THE DIAGONAL ARE RESPONSIBLE FOR THE COUPLING BETWEEN E_x, E_y

Eigenvalues : PROPAGATION → $\beta_{R,L} = \frac{2\pi}{\lambda} \sqrt{\epsilon_{\perp} \pm \delta\epsilon}$
CONSTANTS

Eigenvectors : FIELDS → $E_x = \pm j E_y$

we get WAVES WITH CIRCULAR POLARIZATION :

refractive index: RIGHT $n_R = \sqrt{\epsilon_{\perp} + \delta\epsilon}$

LEFT $n_L = \sqrt{\epsilon_{\perp} - \delta\epsilon}$

BIREFRINGENCE: $n_R - n_L \approx \frac{\delta\epsilon}{\sqrt{\epsilon_{\perp}}}$

• A magneto-optic medium presents CIRCULAR BIREFRINGENCE,

it can ROTATE THE POLARIZATION PLANE by an angle

$$\theta = \frac{1}{2}(\beta_R - \beta_L) \cdot L = \frac{\pi \cdot \delta\epsilon}{\lambda \cdot \sqrt{\epsilon_{\perp}}} \cdot L \rightarrow \text{sensitivity to rotation is inversely proportional to } \lambda$$

Ellipticity is not changed, but just the orientation

• Electro-optic characteristics CAN BE INDUCED BY A MAGNETIC FIELD IN THE DIRECTION OF PROPAGATION

↳ FARADAY EFFECT

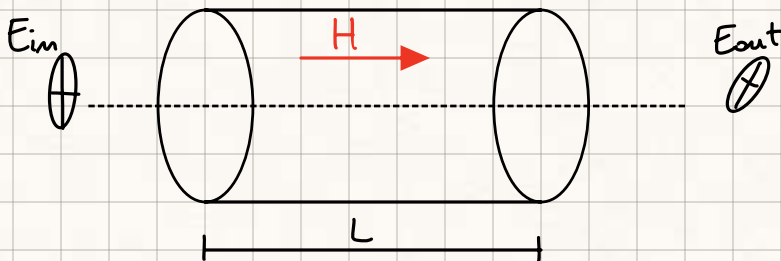

induced birefringence depends linearly on longitudinal component of H

ROTATIONAL ANGLE: $\theta = V \cdot B \cdot L$

V: Verdet constant [rad/T]

rotation is inverted for the backwards direction

$B = \mu_0 H$ Induction vector

OPTICAL ISOLATOR

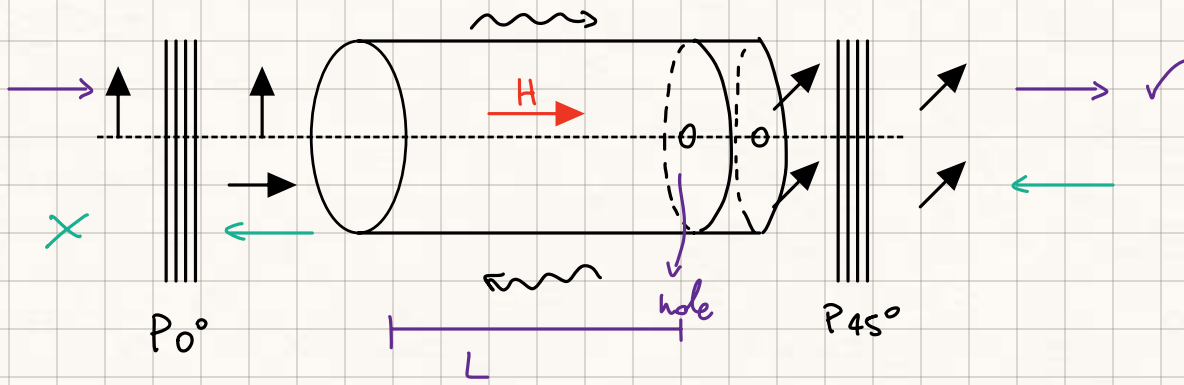

this device is sensible to the state of polarization of the light

we want $L \rightarrow \theta = 45^\circ$

we exit the (linear) device with 45° polarization

↳ ELIPTICITY IS KEPT

Putting the device backwards doesn't allow the light to go through \rightarrow horizontally polarized

THE MAGNETIC MATERIAL ALLOWS FOR THE ASYMMETRIC BEHAVIOUR FOR FORWARD AND BACKWARD PROPAGATION

↳ a birefringent section would give us light not altered in both directions (rotation independent from propagation direction)

CIRCULATOR (POLARIZATION INDEPENDENT)

CIRCULATORS: three-or-more ports PASSIVE DEVICES

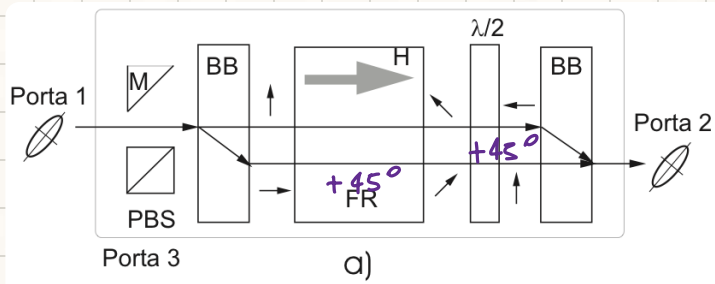

allow to pass only in one direction

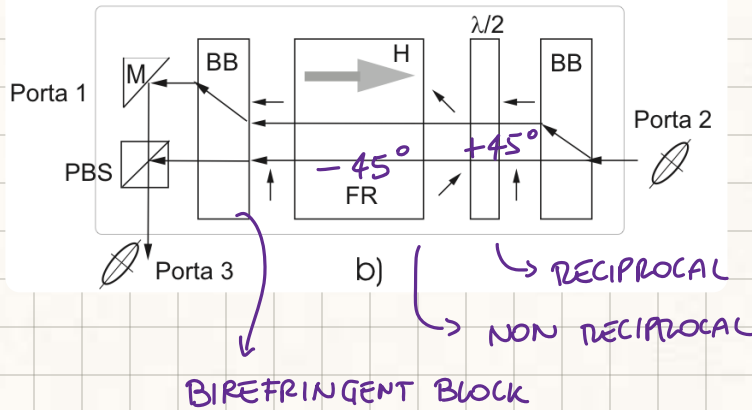

• ENTER FROM 1:

the birefringent block separates horizontal and vertical polarization

↳ vertical and horizontal exit parallel to each other

A FARADAY ROTATOR + $\lambda/2$ PLATE rotated by $22.5^\circ \rightarrow 90^\circ$ ROTATION

Arriving at port 2 the vertical one goes straight and the horizontal gets recombined

• ENTER FROM 2:

The behaviour is reciprocal \rightarrow split horizontal and vertical polarization

Faraday rotator is NOT RECIPROCAL \rightarrow in the end the polarization is NOT ROTATED

A mirror sends deflects the beam from port 1 and it's directed to port 3
PORT 1 IS ISOLATED

NONRECIPROCALITY CAN BE INDUCED ALSO BY TIME MODULATION

MODULATION - ELECTRO OPTIC EFFECT

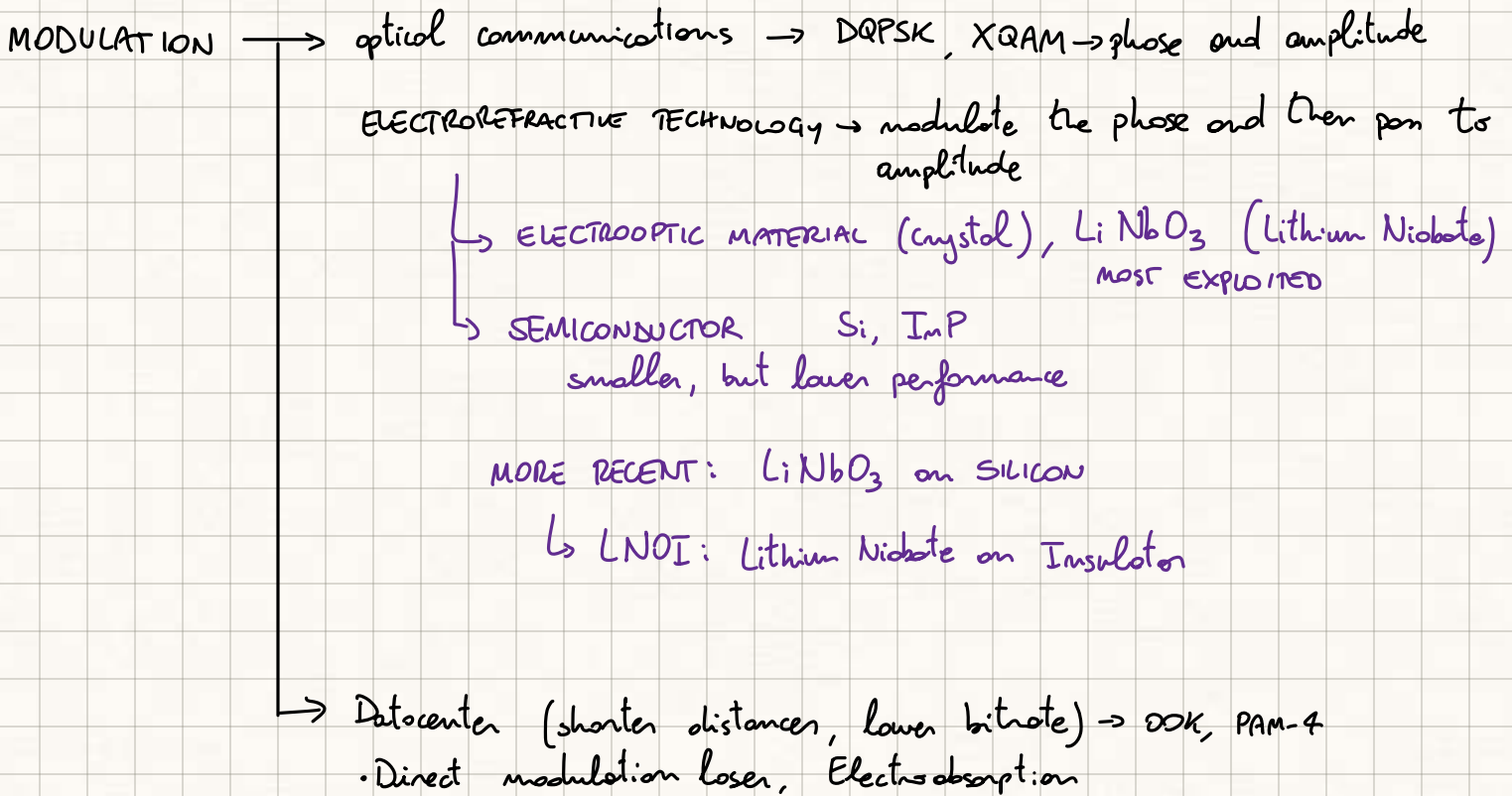

ELECTROOPTIC MODULATION

Susceptibility of the material in general depends on the (external) Electric field applied to the material

↳ it's a TENSOR:

$$\chi(E) = \chi_0 + \underbrace{\frac{\partial \chi(E)}{\partial E} \Big|_{E=0}}_{\text{POCKEL EFFECT}} \cdot E + \underbrace{\frac{\partial^2 \chi(E)}{\partial E^2} \Big|_{E=0}}_{\text{KERR}} \cdot E^2 + \dots$$

$$n = \sqrt{\epsilon_m}$$

Pockel effect exists in a NON CENTROSYMMETRIC CRYSTAL (asymmetry in the molecule)

Kerr is always present

↳ Pockel's depends on the sign of E while Kerr only on the amplitude

Tensor of the refractive index

$$\underline{\underline{\epsilon}} = \begin{bmatrix} \epsilon_x & 0 & 0 \\ 0 & \epsilon_y & 0 \\ 0 & 0 & \epsilon_z \end{bmatrix}$$

if $\epsilon_x = \epsilon_y = \epsilon_z \rightarrow$ ISOTROPIC MATERIAL

• LiNbO₃

UNIAXIAL MATERIAL

it has: $\epsilon_x = \epsilon_y = m_o^2$,

ordinary refractive index

$$m_o = 2,297$$

$$\neq \epsilon_z = m_e^2$$

extraordinary refractive index

$$m_e = 2,208$$

simplify direction of propagation on one of the axis of the material

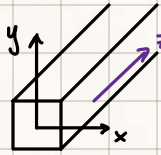

we consider direction of propagation along $z \rightarrow$ OPTICAL AXIS

the wave is $e^{-j\beta z} = e^{-j\frac{2\pi}{\lambda} m_o \cdot z}$

ordinary, m seen by the field component in the transverse direction to propagation

For the plane wave the material is ISOTROPIC when propagating along the optical axis

We have a name for the AXIS ORIENTATION:

given the wafer \rightsquigarrow

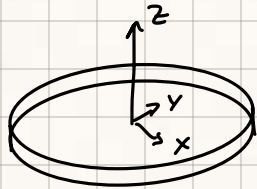

Z-cut \rightarrow z axis exits from the wafer

also Y-cut, X-cut

ELECTRO-OPTIC EFFECT

• HOW MUCH CHANGE OF REFRACTIVE INDEX IS INDUCED BY THE FIELD

we have three axis of the material and three directions of application of the electric field

$$\Delta m_i = -\frac{m_i^3}{2} \cdot \sum_{j=1}^3 r_{ij} \cdot E_j$$

where $i = 1, \dots, 6$

\downarrow
6 because the 3 axis can also rotate based on the electric field

$i = x, y, z, \text{ angle } 1, \text{ angle } 2, \text{ angle } 3$

ELECTRO-OPTIC COEFFICIENTS: r_{ij} linear relation between applied electric field and the variation for that direction

$$\Delta m = r_{ij} \cdot E_j = -\frac{m_i^3}{2} \begin{bmatrix} -r_{22} E_y + r_{13} E_z & -r_{22} E_y & r_{51} E_x \\ -r_{22} E_y & r_{22} E_y + r_{13} E_z & r_{51} E_y \\ r_{51} E_x & r_{51} E_y & r_{33} E_z \end{bmatrix}$$

ASSUME Z-CUT WAVEGUIDE:

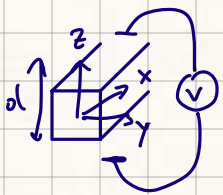

$E_z = \frac{V}{d}$ along z, we propagate along x $\rightarrow \Delta m_z, \Delta m_y$?
for the β

$$\Delta m_z = -\frac{m_e^3}{2} \cdot r_{33} E_z \rightarrow \text{SUM LINE } m^o 3 \text{ but keep only elements with } E_z$$

$$\Delta m_y = -\frac{m_o^3}{2} \cdot r_{13} \cdot E_z \rightarrow \text{SUM OF } z^{\text{nd}} \text{ line, keep only } E_z$$

$E = \frac{V}{d} \rightarrow$ high voltage at radiofrequency is EXPENSIVE
 \rightarrow low distance (metal near light can be dangerous)

REFRACTIVE INDEX CHANGE FOR "DIAGONAL" ELECTRIC FIELD

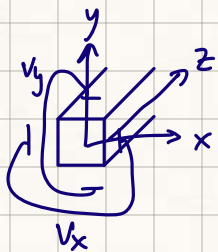

$$\text{TM: } E_y \rightarrow e^{j \frac{2\pi}{\lambda} m_y z}$$

$$\Delta m_y = -\frac{m_o^3}{2} \left[-r_{22} E_x + r_{22} E_y + \emptyset + r_{51} E_y \right]$$

for the TE mode we calculate Δm_x

r_{33} is the largest one = 30,8 pm/V

TO USE r_{33} : we need to align \vec{E} to the electric field of the light (Mode)

↳ we cannot propagate along $z \rightarrow$ we use $E_{\text{mod } z}$

use : TM mode for z -cut

TE mode for x -cut prop. along y

y -cut prop. along x

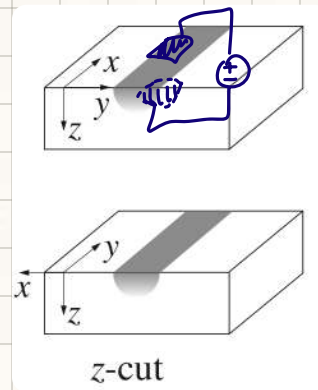
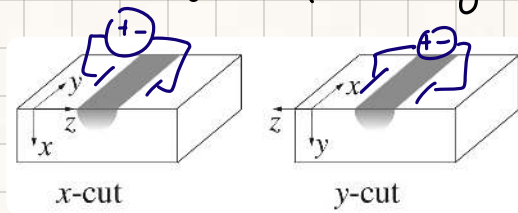

TECHNOLOGY OF LiNbO_3

we realize a Titanium photoguide : $\text{Ti} : \text{LiNbO}_3$

↳ Titanium diffusion

we cover the wafer with photoresist and etch the circuit blueprint

↳ we deposit the titanium by evaporation and we eliminate the photoresist

everything is put into an oven and Titanium gets diffused,

we need enough titanium:

TRADEOFF: REFRACTIVE INDEX (high enough) VS METAL PRESENCE (attenuation)

For the electrodes we need a quite intense electric field:

for low frequency we can use Al, or gold for high frequencies

↳ to increase adhesion we need a thin layer of chromium (adhesive)

The electrode must be put in a suitable way:

we use a low layer of SiO_2 in order to isolate the optical field, on top of which the electrodes are put

POSITION OF THE ELECTRODES:

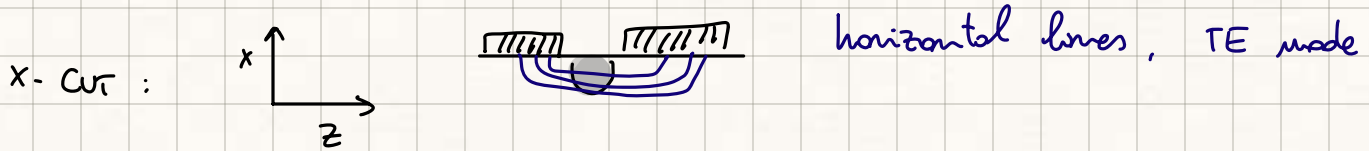
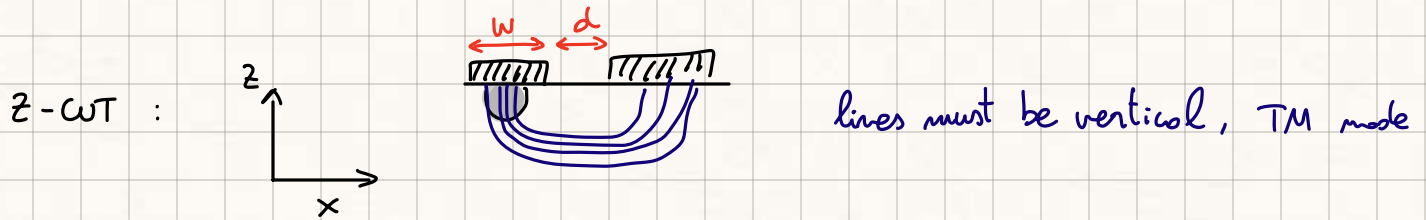

tradeoff homogeneity - intensity of the modulating field \rightarrow depends on d

\hookrightarrow WE NEED TO MAXIMIZE δn

OVERLAP OF ELECTRIC FIELD WITH OPTICAL MODE:

$$\Gamma = \frac{d}{V} \int E |\Psi|^2 d\sigma \quad \text{integral over the guide section}$$

$$0 < \Gamma < 1 \quad \rightarrow \quad \Delta\varphi = \frac{2\pi}{\lambda} \cdot \Delta n \cdot L = \frac{-\pi}{\lambda} \cdot n_e^3 \cdot r_{33} \cdot \left(\frac{\Gamma}{d}\right) \cdot \underbrace{V \cdot L}_{\text{AVAILABLE VOLTAGE}}$$

POSITION OF THE ELECTRODES
(capacitance C_e)

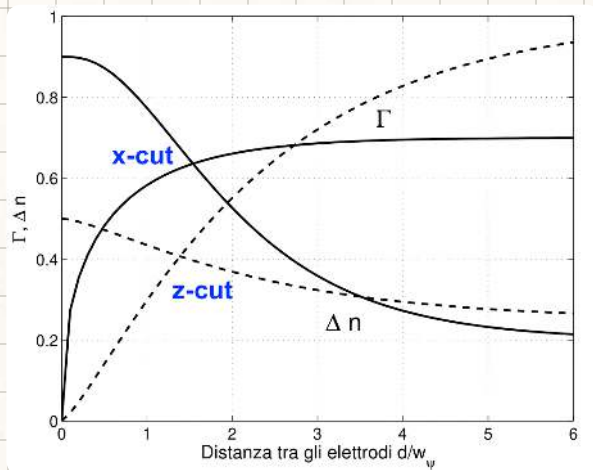

Γ grows with the distance \rightarrow better overlap

BUT \rightarrow highest δn is for short distances

x-cut is better for short distances but δn decreases fast,
z-cut better for large distances

ELECTRODES:

Shape of the electrodes defines electrooptic efficiency and frequency response of the modulator and quality of the signal

Bandwidth is limited by the electrodes

DIELECTRIC CONSTANT SEEN BY THE MODULATING FIELD:

$$\epsilon_{\text{eff}} = \frac{\epsilon_{rs} + 1}{2} \approx 1.8 \quad \text{average between air and substrate}$$

• LUMPED ELECTRODES (concentrated)

DIMENSIONS ARE SMALLER THAN THE MODULATING FIELD'S WAVELENGTH $L \ll \lambda$

↳ tension is the same everywhere, can be modeled as a capacitance

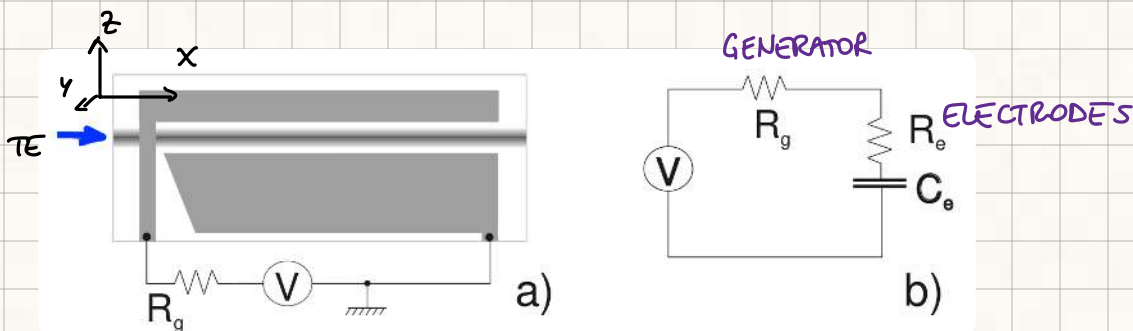

C_e depends on dielectric constant and device's geometry

↳ objective: try to limit the capacity, time constant

lumped when $L \ll \frac{c}{2 f_m \cdot \sqrt{\epsilon_{\text{eff}}}}$

↳ max modulation frequency

Piloting circuit constitutes the highest limitation \rightarrow Resistance ($R_e + R_g$), C_e

$$f_T = \frac{1}{2\pi(R_e + R_g)C_e} \quad \text{cutoff modulation frequency}$$

↓
 R_e depends on RESISTIVITY and AREA of the electrodes
 $R_g \gg R_e$

for typical $R_g \approx 3 \text{ pF}$ $f_m \cdot L = 1 \text{ GHz} \cdot \text{cm}$

↳ increasing V ($\propto L^{-1}$) we can increase bandwidth reducing length

Lumped electrodes are used UP TO HUNDREDS OF MHz

typically $C_e \approx \epsilon_0 \epsilon_r \cdot \frac{Lw}{d}$

• TRAVELLING WAVE ELECTRODES (distributed)

used for $f_m \approx \text{GHz}$, length L comparable to λ_m

we model them as TRANSMISSION LINE

↳ it must be loaded with the characteristic impedance to avoid reflections
 MATCHING CONDITION

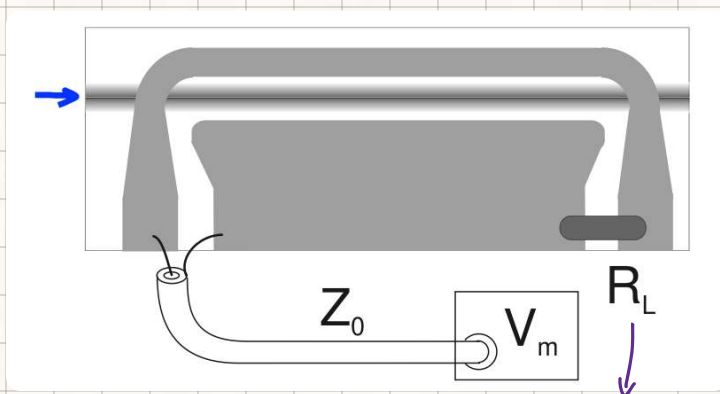

↓
 adapted load
 soldered on the electrodes

Typically $R_i, R_g, Z_0 = 50 \Omega$

$\epsilon_r \text{ LiNbO}_3 \approx 40$, $\epsilon_{r \text{ eff}} \approx 20$

$n_e, n_o \approx 2,2$

$d, w = 10 \div 20 \mu\text{m}$

$L \approx \text{few cm}$

Signal starts at the signal generator, pulse propagates along the waveguide and dissipated at the load R_i

• VELOCITY MISMATCH

for travelling wave electrodes we do not have the limit on bandwidth set by the time response of the circuit

↳ it's given BY THE DIFFERENCE OF TRANSIT TIME BETWEEN OPTICAL AND RF SIGNAL

speed of RF signal: $v_{RF} = \frac{c}{\sqrt{\epsilon_r}} = \frac{1}{\sqrt{L \cdot C}} = \frac{c}{4,4} \sim \frac{1}{2} v_0$

$$v_0 = \frac{c}{M_{L:NbO_3}} = \frac{c}{2,2}$$

RF signal is SLOWER THAN THE OPTICAL ONE

↳ Optical wave is not modulated with the same field for the whole path

we do not OBTAIN AN EXACT REPLICA, it causes:

DISTORTION + INCREASED DURATION, modulation is less effective

TRAVELLING WAVE allows for small modulating voltage, not that expensive

it's very long and does not have fm limit

↳ HAS VEL. MISMATCH PROBLEM

this limits the max mod. frequency at ~ 10 GHz

induced phase shift in a small section dz :

$$\delta\varphi = \frac{2\pi}{\lambda} \cdot \frac{m_e^3}{z} \cdot r_{33} \cdot \frac{V(z)}{d} \cdot dz$$

for an entire section:

$$\Delta\varphi = \int_0^L \delta\varphi dz = \int_0^L \frac{2\pi}{\lambda} \cdot \frac{m_e^3}{z} \cdot r_{33} \cdot \frac{V(z)}{d} \cdot dz$$

$V(z)$ for a sinusoidal signal: tension along the electrodes

$$V(z) = V_0 \cdot \sin\left(\frac{2\pi \cdot f_m}{c} \cdot \sqrt{\epsilon_{\text{eff}}} \cdot z - 2\pi \cdot f_m \cdot t\right)$$

the optical front gets influenced at t_0

$$V(z, t_0) = V_0 \cdot \sin\left(\frac{2\pi \cdot f_m}{c} (\sqrt{\epsilon_{\text{eff}}} - m_{\text{eff}}) \cdot z - 2\pi \cdot f_m \cdot t_0\right)$$

VELOCITY MISMATCH PHASE COMPONENT:

$$\Delta\varphi(t) = \Delta\beta_0 \cdot L \cdot \frac{\sin(\pi f_m / f_0)}{\pi f_m / f_0} \cdot \sin(2\pi f_m t - \pi \frac{f_m}{f_0})$$

$$\Delta\beta_0 \cdot L = \Delta\varphi_0 = \frac{2\pi}{\lambda} \cdot \frac{m_e^3}{2} \cdot r_{33} \cdot \frac{V_0}{d} \cdot \Gamma \cdot L \quad \text{MODULATION WITHOUT MISMATCH}$$

$$f_0 = \frac{c}{L(\sqrt{\epsilon_{\text{eff}}} - m_{\text{eff}})}$$

when $f_m = f_0 = 15 \text{ GHz}$ MODULATION IS NULL

↳ increasing frequencies the two waves slide on on top of the other

INTERACTION LENGTH GETS SMALLER AND ELECTROOPTIC EFFECT WEAKER

with low mismatch we can have a long modulator with low values of V

the induced phase shift as a function of frequency is:

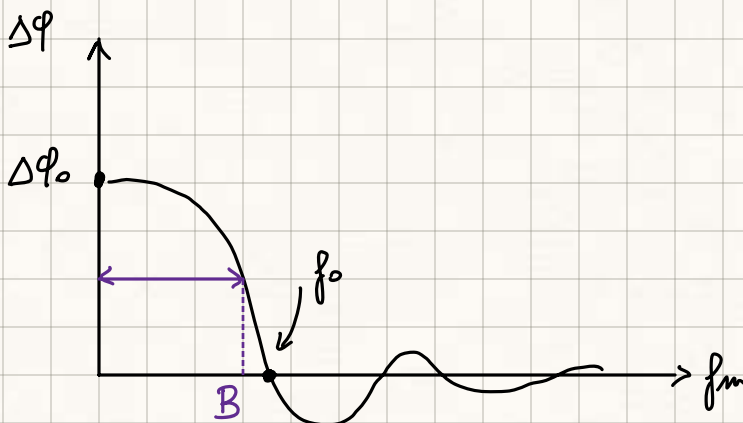

bandwidth of the modulator: $B = f_0 \cdot \frac{2}{\pi}$

VELOCITY MATCHING: to reduce velocity mismatch, we can try complex structures to reduce the EFFECTIVE DIELECTRIC CONSTANT AND SPEED UP THE RF WAVE

• ATTENUATION IN ELECTRODES:

2nd limitation for modulation bandwidth

we ADD THE TERM $e^{-\alpha_{RF} \cdot z}$ to $\Delta\phi$

$$\int_0^L d\phi dz = \int_0^L \frac{2\pi}{\lambda} \cdot \frac{m_e^3}{2} \cdot v_{33} \cdot \frac{V(z)}{d} \cdot \Gamma \cdot e^{-\alpha_{RF} \cdot z} dz$$

comes from metal conductivity, penetration in the electrodes

↳ surface resistance $R_s = \sqrt{\pi f \rho \mu_0}$

increases at high frequency, SKIN EFFECT reduces penetration

SKIN DEPTH: $\delta = \sqrt{\frac{\rho}{\pi \mu_0 f}} \sim 0,76 \mu\text{m} (10 \text{ GHz})$

$f \rightarrow \alpha \rightarrow Z_0, N_{RF}, \epsilon_{RF}, \alpha$

$$\alpha_{RF} = \frac{R_s}{2 \cdot W \cdot Z_0} \sim 0,4 \text{ dB/cm}$$

it creates a loss in phase modulation:

$$\Delta\phi = \Delta\phi_0 \cdot \frac{1 - e^{-\alpha_{RF} \cdot L}}{\alpha_{RF} \cdot L}$$

 ELECTRODE

↳ current stays on the surface, we should increase the width of the electrode

INTENSITY MODULATORS

use phase modulation and transform into intensity

CLASSICAL SCHEME: MZ + ELECTRODES (balanced)

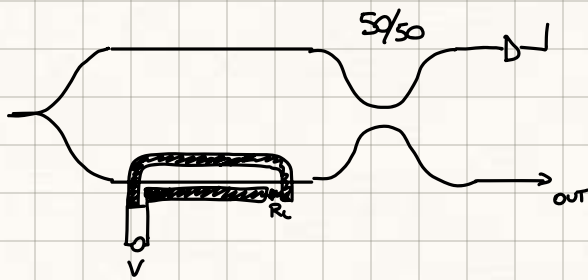

Photodiode to monitor the functioning of the device

$$I(t) = \cos^2\left(\frac{\Delta\phi(t)}{2}\right) \quad \text{but shape of the intensity doesn't match the shape of the modulation}$$

the conversion is not LINEAR

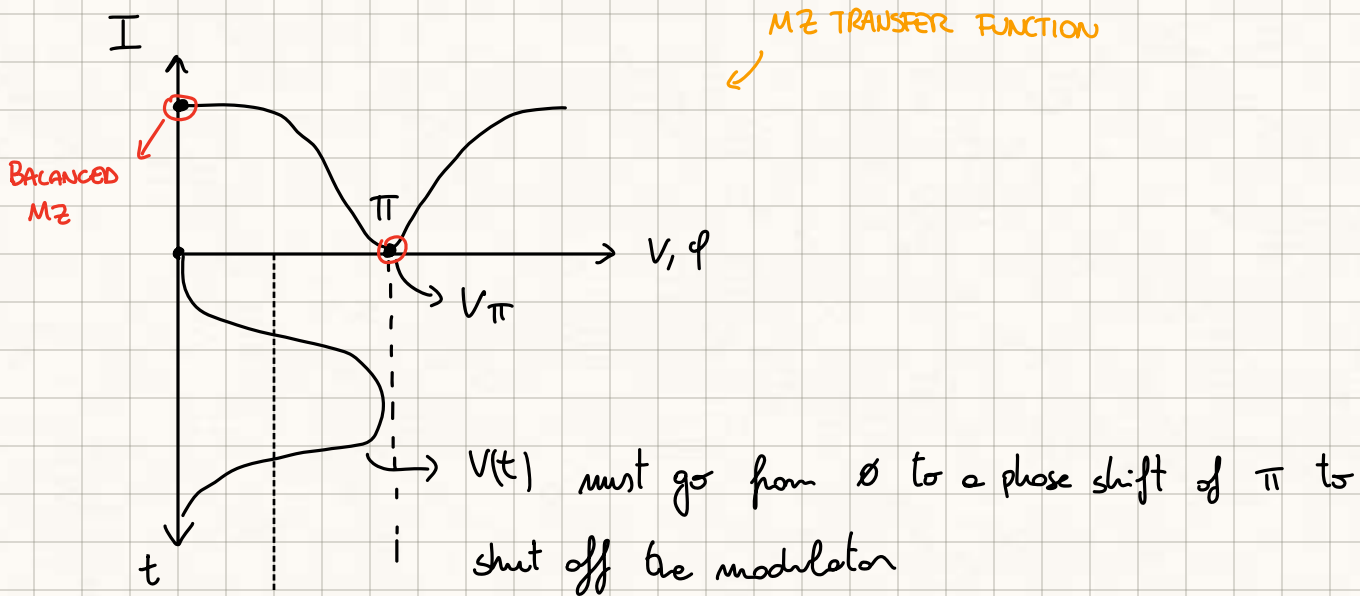

Applying the voltage we get a phase modulation:

$$V = 0 \quad I_{\max}, \quad \Delta\phi = 0$$

$$V = V_{\pi} \quad I_{\min} = 0, \quad \Delta\phi = \pi$$

V_{π} is a characteristic in the datasheet

↳ voltage to induce a π shift to the phase modulator

PROBLEM: • Average voltage is not 0 → we are applying DC power that gets dissipated

RF amplifiers don't have DC

↳ • We exploited only one waveguide, using both we can double the effect

PUSH-PULL CONFIGURATION:

can reduce by 2 the voltage V_{π} → needed power is reduced by 4

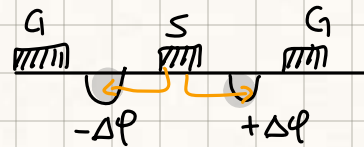
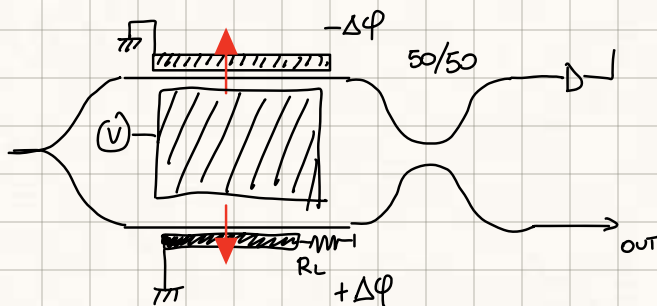

we use some taper around the electrodes and the central section to remove the 50 Ω requirement at the central section

↳ the condition holds at the generator, cable and load, then we do a line transformation in the central part

in a push-pull $\frac{V_{\pi}}{2}$ is halved

PROBLEM: we need a LINEAR RELATION, we work at the HW

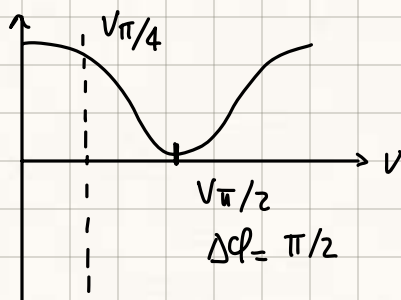

$(-\frac{V_{\pi}}{4}; \frac{V_{\pi}}{4})$ modulating signal
OF PUSH PULL, MODULATOR

WORKS IN QUADRATURE

would be $0 \rightarrow V_{\pi}$ for a single electrode

the bias can be added to better control the working point also by using an additional electrode

TYPICAL CONTROL SCHEME: add a really low frequency ($\sim 1\text{kHz}$) signal, mV

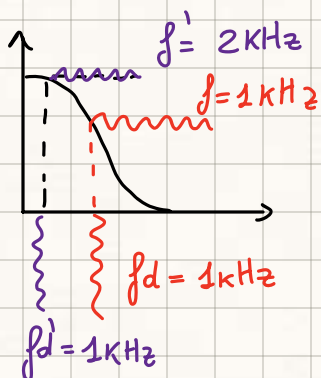

we check f_d at the monitor until the two frequencies are not linear

TRANSFER FUNCTION OF THE MODULATOR: (ideal MZ)

$$H(\phi, V) = \frac{1}{2} e^{-j\Delta\phi_1} + \frac{1}{2} e^{-j\Delta\phi_2} = \cos^2\left(\frac{\Delta\phi}{2}\right)$$



CHIRP EFFECT:

$$H(\phi, V) = \frac{1}{2} e^{-j\Delta\phi_1} + \frac{1}{2} e^{+j\Delta\phi_2} = e^{-j\left(\frac{\Delta\phi_1 + \Delta\phi_2}{2}\right)} \cdot \cos^2\left(\frac{\Delta\phi}{2}\right)$$

↓
time dependent

it's a RESIDUAL PHASE MODULATION, on top of the amplitude term

in case of a PUSH-PULL $\Delta\phi_1 = -\Delta\phi_2$, chirp is 0

has the same shape of the intensity

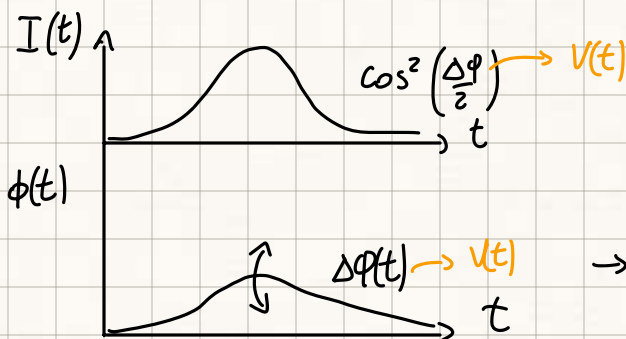

→ when $\Delta\phi_2 = 0$, single electrode
see MAX PHASE MODULATION (amplitude)

it's also induced by the not ideal splitter, terms $(\frac{1}{2})$ are not exact

- since the signal is phase modulated after some km the pulse will be different if it starts as real or otherwise

chromatic dispersion plays with the chirp

↳ use a DUAL-DRIVE MODULATOR to control $\Delta\phi_1, \Delta\phi_2$ and provide the wanted chirp

↳ COMPENSATE THE CHROMATIC DISPERSION

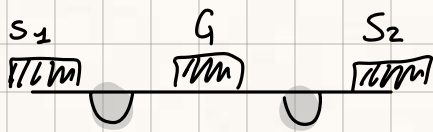

Combining Phase + Amplitude we realize complex constellations

MACH-ZENDER → INTENSITY MODULATOR

PUSH-PULL CONFIGURATION: poor amplitude modulation, $s(t)$ real

DUAL DRIVE: $s(t)e^{j\phi(t)}$ CHIRP → introduce a phase modulation used to counteract chromatic dispersion
↳ DOOR TO COMPLEX MODULATION SCHEMES

BEST BIAS TO WORK THE MODULATOR → quadrature point

The \cos^2 transfer function of the modulator induces some distortion in the generated signal

Another possibility to turn phase into amplitude is another filter → RING RES.

SIMULATION:

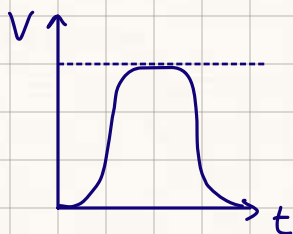

we send an electrical pulse

• ideal mod:

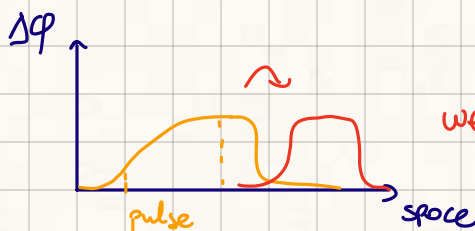

we obtain an exact replica of the electrical pulse in the optical domain

• velocity mismatch:

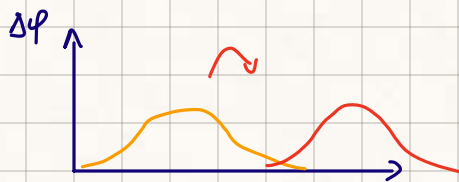

light travels faster
↳ BROADENING AND DISTORTION

if the pulse is short we could get non-maximal phase modulation

• Attenuation:

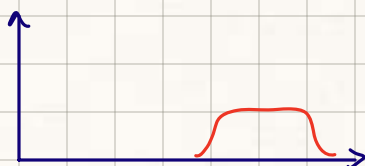

exact shape, but modulated phase is lower

if the speed of the electrical signal is faster we have compression

↳ longer spectrum of the opt. signal (may lead to interference)

- Pulses close together + VELOCITY MISMATCH

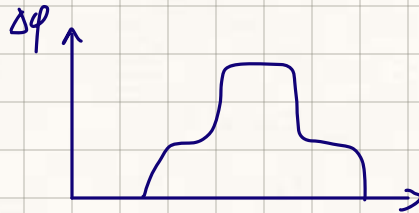
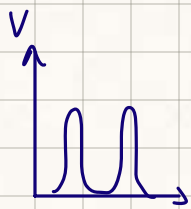

→ they broaden and overlap

- Simulating AT f_0 → modulation is CANCELLED

we send a sinusoidal signal

$$\sin(2\pi f_0 t)$$

$$f_0 = 13,3 \text{ GHz}$$

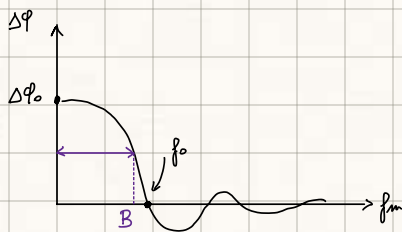

$$f_0 = \frac{c}{L(\sqrt{\epsilon_r} - n_{\text{eff}})}$$



- MZ simulation at V_{π} , no mismatch

for V_{π} we get a perfect replica of the sinusoidal signal as expected



Alternative ways to produce a LiNbO₃ waveguide:

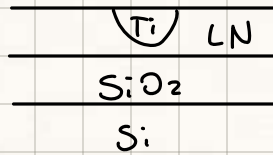

The trapezoidal shape can induce polarization rotation in bends → TE gets coupled with TM

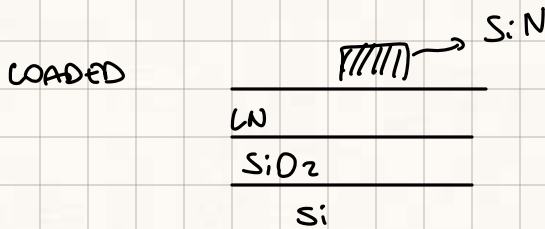

HETEROGENEOUS



MULTIPLEXING:

wavelength, polarization, constellation, space (modes)
 ↓ ↓ ↓ ↓
 WDM PDM Phase + Amplitude

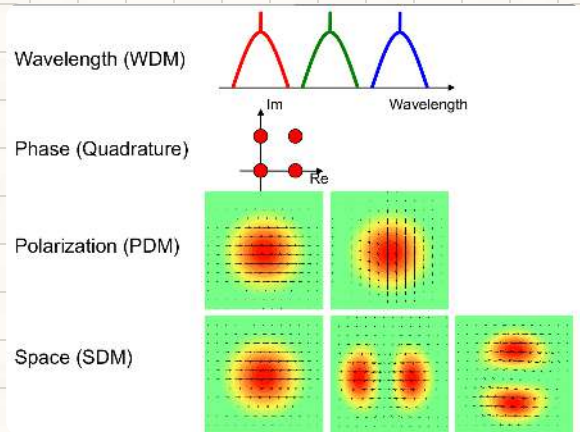

OOK:

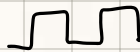
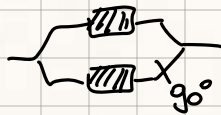

reception by photodetector

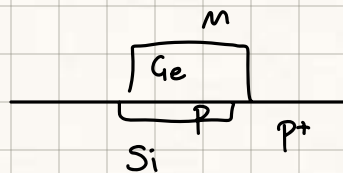

DBPSK: modulate on one axis

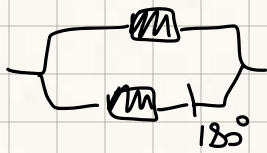
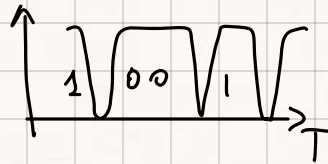
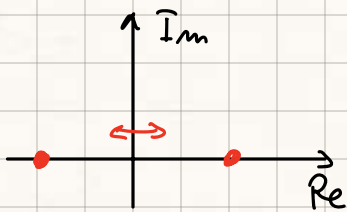

push pull, reception with two photodiodes, unbalanced MZ

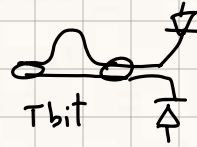

↳ unbalance by $\frac{1}{R_b}$

QPSK:

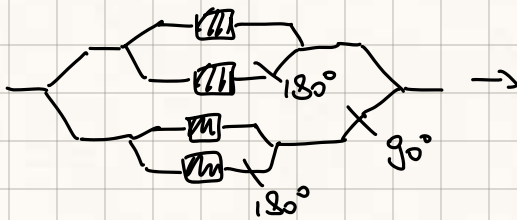
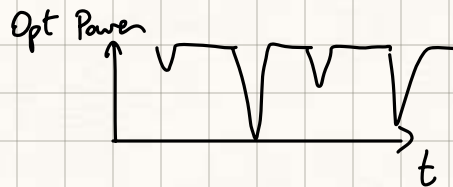
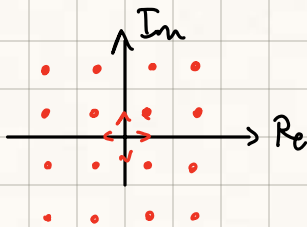

NESTED MZ

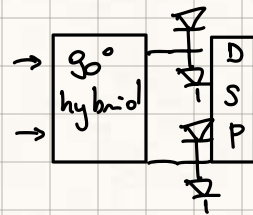
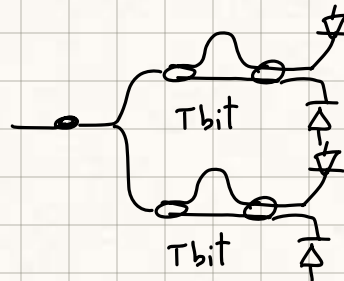

16-QAM

we use 4 MZ \rightarrow 8 modulators

or we use the couple of MZ in quadrature, but we use a MULTILEVEL ELECTRICAL SIGNAL